

# 5000 Series

## User Manual UHF Wireless Systems

### **ATW-R5220**

Dual Receiver

### **ATW-R5220DAN**

Dual Receiver with Dante Output

### **ATW-T5201**

Body-Pack Transmitter

### **ATW-T5202**

Handheld Transmitter (without capsule)

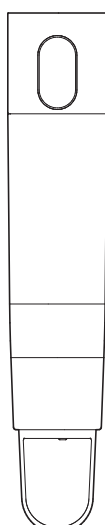
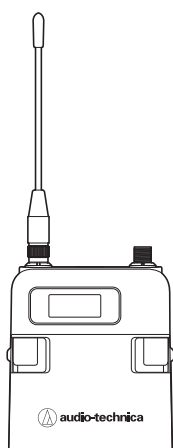
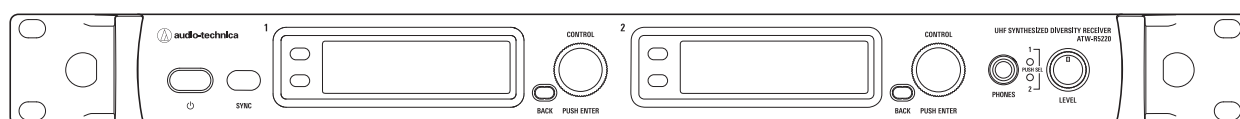

# Contents

<b>Introduction</b> .....	2	<b>Making connections (basic connections)</b> .....	27
<b>Important information</b> .....	2	<b>Making connections (cascade connections)</b> .....	28
<b>Notes on use</b> .....	4	<b>Achieving stable reception</b> .....	29
<b>Maintenance</b> .....	4	<b>Rack-mounting the receiver</b> .....	29
<b>Part names and functions</b> .....	5	<b>Troubleshooting</b> .....	30
ATW-R5220/ATW-R5220DAN .....	5	ATW-R5220/ATW-R5220DAN .....	30
ATW-T5201 .....	7	ATW-T5201/ATW-T5202 .....	30
ATW-T5202 .....	8	<b>Dimensions</b> .....	31
<b>How to insert batteries</b> .....	9	ATW-R5220/ATW-R5220DAN .....	31
ATW-T5201 .....	9	ATW-T5201 .....	32
ATW-T5202 .....	9	ATW-T5202 .....	32
<b>How to attach and detach the interchangeable microphone capsule (only for ATW-T5202)</b> .....	10	<b>Specifications</b> .....	33
How to attach .....	10	Overall system specifications.....	33
How to remove .....	10	ATW-R5220/ATW-R5220DAN .....	33
<b>How to read the display</b> .....	11	ATW-T5201 .....	34
ATW-R5220/ATW-R5220DAN .....	11	ATW-T5202 .....	34
ATW-T5201/ATW-T5202 .....	13		
<b>How to operate</b> .....	14		
Basic operation .....	14		
Using IR SYNC .....	14		
<b>Settings</b> .....	15		
ATW-R5220/ATW-R5220DAN .....	15		
ATW-T5201/ATW-T5202 .....	15		
<b>Setting ATW-R5220/ATW-R5220DAN</b> .....	16		
List of setting items .....	16		
Setting the operating frequency .....	16		
Setting the channel (receiver) name .....	16		
Setting the audio output level.....	17		
Scanning for open channels .....	17		
Setting transmitters via IR SYNC .....	17		
Setting the squelch level.....	18		
Setting the system-related functions .....	18		
Setting network.....	21		
Using test tool.....	22		
Setting DANTE .....	22		
<b>Setting ATW-T5201/ATW-T5202</b> .....	23		
List of setting items .....	23		
Setting the transmission frequency .....	23		
Setting the channel (transmitter) name .....	23		
Setting the microphone input gain .....	24		
Selecting the microphone input gain.....	24		
Setting the RF transmission output .....	24		
Setting HPF (High-Pass Filter).....	24		
Setting lock .....	24		
Setting the function .....	25		
Setting the system-related functions.....	25		
<b>How to attach the transmitter (ATW-T5201)</b> .....	27		

## Introduction

Thank you for purchasing this Audio-Technica product.

Before using the product, read through this user manual to ensure that you will use the product correctly. Please keep this manual for future reference.

The frequency band can be checked by the model number of the product. You can confirm the model number of your product by the rating label.

Example: ATW-R5220DG1

Band name

Model number	Band name	Operating frequencies
ATW-R5220/ATW-R5220DAN	DG1	470.125 to 699.875 MHz
	DF1	470.125 to 607.875 MHz, 657.100 to 662.900 MHz
ATW-T5201/ATW-T5202	DE1	470.125 to 590.000 MHz
	EG1	580.000 to 699.875 MHz
	EF2	580.000 to 607.875 MHz, 657.100 to 662.900 MHz

## Important information

### Warning:

- To prevent fire or shock hazard, do not expose this apparatus to rain or moisture.

### Caution:





- Do not expose this apparatus to drips or splashes.
- To avoid electric shock, do not open the cabinet.
- Refer servicing to qualified personnel only.
- Do not expose this apparatus to excessive heat such as that generated by sunshine, fire or other heat sources.
- Do not subject this apparatus to strong impact.
- This apparatus should be located close enough to the AC outlet so that you can easily grasp the power cord plug at any time.
- In case of emergency, disconnect the power cord plug of this apparatus quickly.
- Do not place any objects filled with liquids, such as vases, on this apparatus.
- To prevent fire, do not place any naked flame sources (such as lighted candles) on this apparatus.
- Do not install this apparatus in a confined space such as a bookcase or similar unit.
- Install this apparatus only in the places with good ventilation.
- To prevent fire, do not cover the ventilation of this apparatus with newspapers, tablecloths, curtains, etc.
- This apparatus with Class I construction shall be connected to the AC outlet with a protective grounding connection.
- This apparatus is not disconnected from the mains as long as it is connected to the AC outlet, even if the unit itself has been turned off.
- In order to maintain proper ventilation, do not place any objects around the rear of this apparatus.
- This apparatus should be placed at least 15 cm away from a rear wall. This apparatus should not be placed near to other electrical apparatuses. Keep the top and sides of this apparatus at least 10 mm away from any other surface if sitting on shelving, such as an audio apparatus rack. Failure to do so may cause this apparatus to overheat which in turn may cause it or surrounding items to catch fire.

### Battery caution:

- Keep batteries out of the reach of children.
- Observe correct polarity as marked.
- Do not expose the battery to excessive heat such as sunshine, fire or the like.
- Always consider the environment issues and follow local regulations when disposing of batteries.
- Remove depleted battery immediately.
- Danger of explosion if battery is incorrectly replaced. Replace only with the same or equivalent type.
- Use only disposable LR06 (AA) alkaline or Ni-MH batteries.
- Do not use new batteries and old ones at the same time.
- Do not use different battery types or models.
- Do not use a leaking battery. If battery leakage occurs, avoid contact with skin. If contact occurs, immediately wash thoroughly with soap and water.
- If battery leakage comes into contact with your eyes, immediately flush with water and seek medical attention.

## Important information

### For customers in the USA/Canada

	<b>CAUTION</b> <b>RISK OF ELECTRIC SHOCK</b> <b>DO NOT OPEN</b>	
<p><b>Caution:</b> To prevent electric shock, do not remove the cover. There are no user-serviceable parts inside. Internal adjustments are for qualified professionals only. Refer all servicing to qualified service personnel.</p>		
	<p>The lightning flash with arrowhead symbol, within an equilateral triangle, is intended to alert the user to the presence of uninsulated "dangerous voltage" within the product's enclosure that may be of sufficient magnitude to constitute a risk of shock to persons.</p>	
	<p>The exclamation point symbol within an equilateral triangle is intended to alert the user to the presence of important operating and maintenance (servicing) instructions in the literature accompanying the product.</p>	

### Important Safety Instructions

1. Read these instructions.
2. Keep these instructions.
3. Heed all warnings.
4. Follow all instructions.
5. Do not use this apparatus near water.
6. Clean only with dry cloth.
7. Do not block any of ventilation openings. Install in accordance with the manufacturer's instructions.
8. Do not install near any heat sources such as radiators, heat registers, stoves, or other apparatus (including amplifiers) that produce heat.
9. Do not defeat the safety purpose of the polarized or grounding plug. A polarized plug has two blades with one wider than the other. A grounding plug has two blades and a third grounding prong. The wide blade or the third prong is provided for your safety. If the provided plug does not fit into your outlet, consult an electrician for replacement of the obsolete outlet.
10. Protect the power cord from being walked on or pinched particularly at plugs, convenience receptacles, and the point where they exit from the apparatus.
11. Only use attachments/accessories specified by the manufacturer.
12. Use only with a cart, stand, tripod, bracket or table specified by the manufacturer, or sold with the apparatus. When a cart is used, use caution when moving the cart/apparatus combination to avoid injury from tip-over.
13. Unplug this apparatus during lightning storms or when unused for long periods of time.
14. Refer all servicing to qualified service personnel. Servicing is required when the apparatus has been damaged in any way, such as power-supply cord or plug is damaged, liquid has been spilled or objects have fallen into the apparatus, the apparatus has been exposed to rain or moisture, does not operate normally, or has been dropped.



### FCC Notice

#### Warning:

This device complies with Part 15 of the FCC Rules. Operation is subject to the following two conditions: (1) This device may not cause harmful interference, and (2) this device must accept any interference received, including interference that may cause undesired operation.

#### Caution:

You are cautioned that any changes or modifications not expressly approved in this manual could void your authority to operate this equipment. Wireless microphone users shall rely on the white space databases in part 15, Subpart H to determine that their intended operating frequencies are available for unlicensed wireless microphone operation at the location where they will be used. Wireless microphone users must register with and check a white space database to determine available channels prior to beginning operation at a given location. A user must re-check the database for available channels if it moves to another location.

**Note:** This equipment has been tested and found to comply with the limits for a Class B digital device, pursuant to part 15 of the FCC Rules. These limits are designed to provide reasonable protection against harmful interference in a residential installation. This equipment generates, uses and can radiate radio frequency energy and, if not installed and used in accordance with the instructions, may cause harmful interference to radio communications. However, there is no guarantee that interference will not occur in a particular installation. If this equipment does cause harmful interference to radio or television reception, which can be determined by turning the equipment off and on, the user is encouraged to try to correct the interference by one or more of the following measures:

- Reorient or relocate the receiving antenna.
- Increase the separation between the equipment and receiver.
- Connect the equipment into an outlet on a circuit different from that to which the receiver is connected.
- Consult the dealer or an experienced radio/TV technician for help.

### For customers in Canada

#### IC statement

CAN RSS-Gen/CNR-Gen

This device complies with INDUSTRY CANADA R.S.S. 210. Operation is subject to the following conditions: (1) This device may not cause harmful interference and (2) this device must accept any interference received, including interference which may cause undesired operation.

This device complies with RSS-102 radiation exposure limits set forth for an uncontrolled environment.

---

## Notes on use

---

- Be sure to read the user manual for any microphone or cable that you attach to the product.
- Disconnect the power cable from the outlet when this product is not in use.
- Turn off the power of this product before connecting or disconnecting cables.
- If you use the product near a TV or radio antenna, you may hear unwanted noise in the television or radio. If this occurs, move the product away from the device.
- Two waves of the same frequency can't be used simultaneously.
- Be careful of interference noise caused by the surrounding radio wave environment and use of multiple systems.
- Wireless systems may be affected by the spark noise of vehicles, dimmer of lighting apparatus, computers, office automation apparatus and electronic musical instruments. Place and use the product where it is less likely to be affected by the above.
- Be sure to use this product in combination with components specified by Audio-Technica.
- Be sure to use a general-purpose LAN that complies with the Ethernet standard (CAT5e or higher, with shielding is recommended).
- Disconnect the LAN cable when not using the network.
- Be sure the connected cable is plugged all the way into the product.
- When you connect the product with a mixer, turn off the phantom power source.
- If you use the product close to an electronic or communications device (such as a mobile phone), the product may produce unwanted noise. If this occurs, move the product away from the device.
- When setting up the product, make sure there are no obstacles between the transmitter and the receiver that might block the signal.
- To prevent the batteries from wearing out, turn the transmitter off when not in use.
- Over time, discoloration may occur due to ultraviolet rays (especially direct sunlight) and friction.
- It is legally prohibited to dismantle and modify this product. In addition, this product is so precisely manufactured that dismantling it could cause electric shock, failure or fire. Never dismantle this product.

### Using multiple wireless systems

---

- If you use more than one device at the same time, use them in the same group.
- When using multiple units simultaneously, maintain 1 meter or more between individual transmitters and 3 meters or more between transmitters and receiver's antennas.
- When using multiple units, power on transmitters one by one, making sure there is no unwanted noise.
- When a howling, beeping or squealing sound is produced during use, turn down the output volume of the connected mixer/amplifier.

---

## Maintenance

---



- If the product becomes dirty or covered with dust, be sure to disconnect the power cable before wiping the product off with a dry and soft cloth.
- Do not use benzine, thinner or electrical contact cleaner, etc. They may deform or otherwise damage the product, or cause operational failure.

# Part names and functions

## ATW-R5220/ATW-R5220DAN

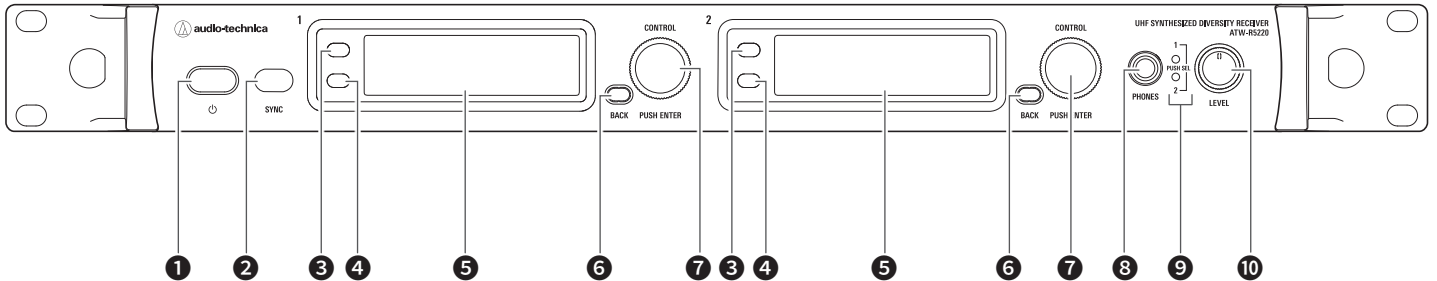
### Front panel



- 1** Power button (  )  
Use to turn the receiver on or place in standby.  
(  : Symbol indicates standby.)
- 2** IR SYNC window  
Use to IR SYNC with the transmitter (ATW-T5201, ATW-T5202).
- 3** Function button 1  
Press to switch between the main display and the level meter display.
- 4** Function button 2  
Press to switch the main display.
- 5** Display  
Displays the receiver state and setting menus.
- 6** BACK button  
Press to take the display back one screen.  
Press and hold to return to the Main screen.
- 7** Control dial  
Displays the setting menu when you press the dial. Turn the dial to select a setting and press to confirm.  
When you press and hold the dial, "TX SYNC" setting screen is displayed.
- 8** Headphone monitor (6.3 mm) output jack  
This is the headphone output jack used for monitoring. It allows you to monitor receivers 1 and 2.
- 9** Headphone channel indicator  
Displays which receiver is being monitored, receiver 1 or 2.  
When normal: lights in white  
When overloaded (headphone output): lights in red
- 10** Headphone volume/Channel switch  
Use when adjusting the volume of the headphones for monitoring.  
Press and release the dial to switch between receivers 1 and 2.
  - Does not affect receiver audio output level.

# Part names and functions

## Rear panel

The figure below is ATW-R5220.

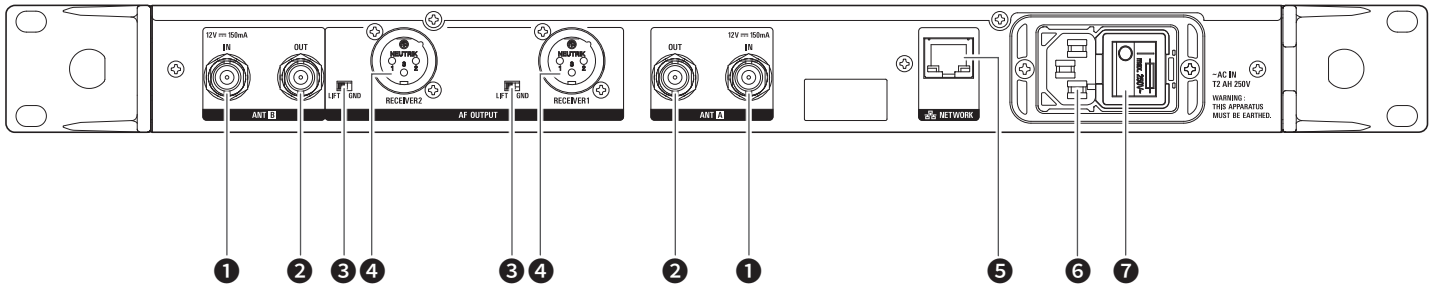

- 1** Antenna input jack  
 ( — : Symbol indicates direct current.)  
 Each jack supplies DC12 V to a connected antenna.  
 Additionally, other compatible antenna accessories (sold separately) can be connected.
- 2** Antenna output jack  
 Distributes and outputs signals input to antennas A and B.  
 By using this jack, it is possible to connect up to seven receivers (eight total).
- 3** Ground lift switch  
 This switch isolates the GND pin of the balanced/unbalanced output from the ground.  
 Normally this is kept in the GND position, but if a hum develops due to a ground loop, switch to the LIFT side.
- 4** Balanced output jack (XLR 3-pin male)



- 5** Network interface  
 By connecting to a PC via Ethernet, you can use the PC for monitoring or control.  
 In the case of ATW-R5220DAN, this can also double as a DANTE output terminal.  
 LAN : 100Base-TX  
 DANTE : 1000Base-T
- 6** AC inlet  
 Connect the power cable.  
 (~: Symbol indicates the current.)
- 7** Main power switch  
 Press to turn the power on/off.

# Part names and functions

## ATW-T5201

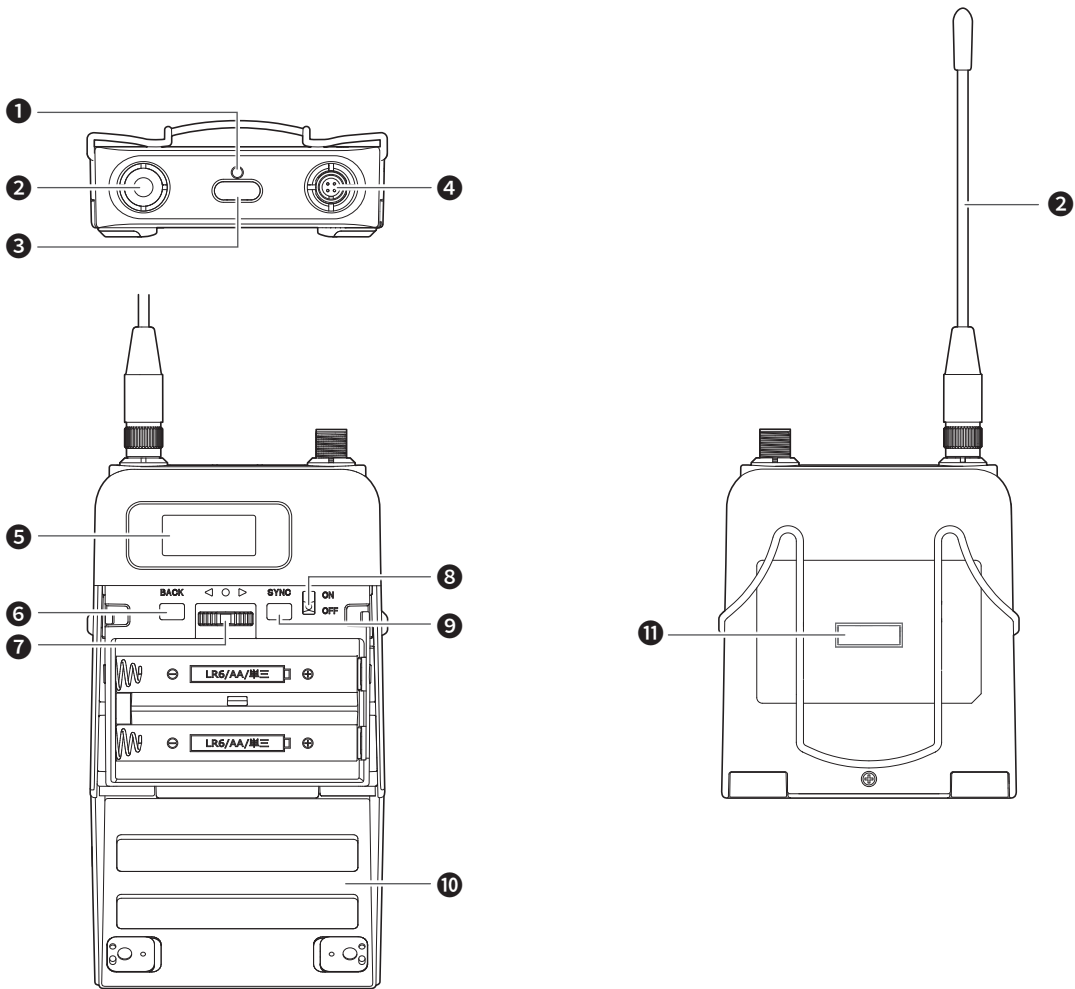

**1** Indicator

LED that shows the status of the transmitter.  
 When the power is turned ON: Solid green  
 When the transmitter is muted: Solid red

**2** Transmission antenna

**3** Function button

Press to turn the screen back on if it shuts off. Press and hold to perform preselected function.

**4** Input connector

Connect a microphone, a headworn microphone, a guitar cable, etc.

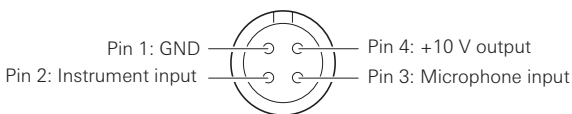

**5** Display

Shows the current status.  
 If no buttons are pressed for a period of 30 seconds, the display will turn off.

**6** BACK button

Press to take the display back one screen.  
 Press and hold to return to the Main screen.

**7** Lever push switch

Use to select various settings.  
 UP (▶)  
 Turn to the right to change a selection.  
 DOWN (◀)  
 Turn to the left to change a selection.  
 SET (●)

**8** Power switch

Use to turn the power on or off.

**9** SYNC button

Use to IR SYNC with the receiver (ATW-R5220/ATW-R5220DAN).

**10** Battery cover

**11** IR SYNC window

Use to IR SYNC with the receiver.



## Part names and functions

### ATW-T5202

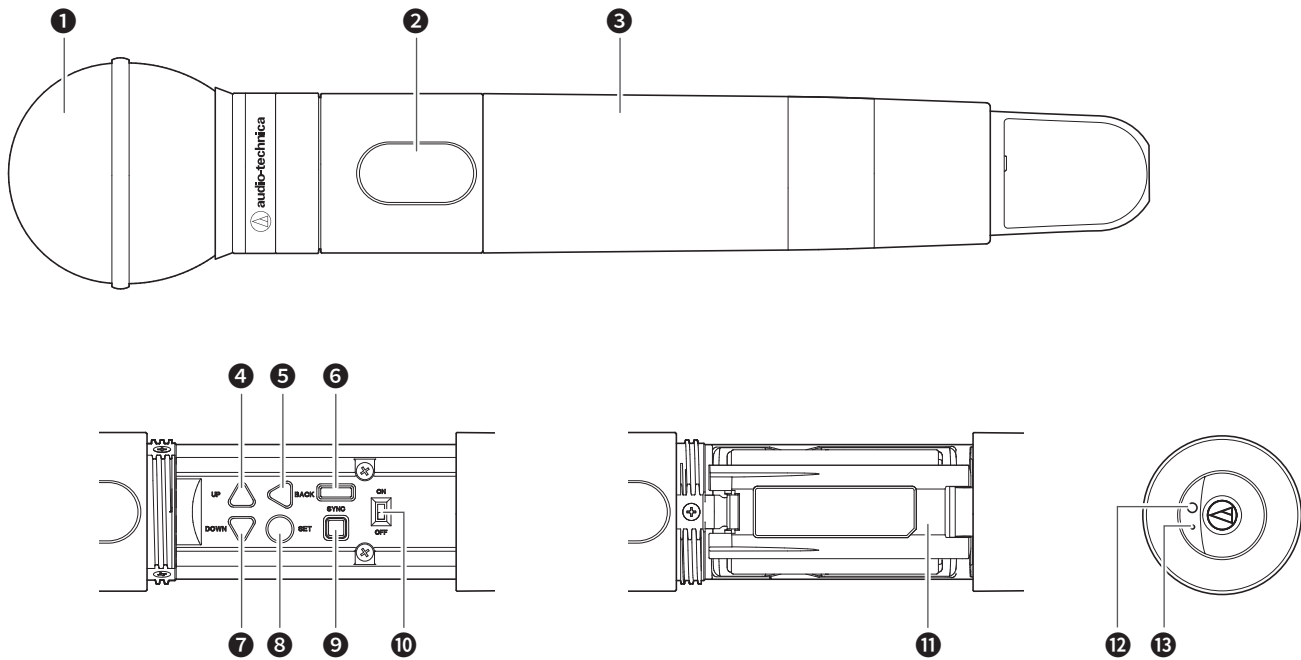

- 1** Interchangeable microphone capsule (sold separately)
- 2** Display  
Shows the current status.  
If no buttons are pressed for a period of 30 seconds, the display will turn off.
- 3** Grip case
- 4** UP button  
Use to select various settings.
- 5** BACK button  
Press to take the display back one screen.  
Press and hold to return to the Main screen.
- 6** IR SYNC window  
Use to IR SYNC with the receiver.
- 7** DOWN button  
Use to select various settings.
- 8** SET button  
Press to display the settings screen. Press the UP/DOWN button, select the setting item, and press to confirm the selection.
- 9** SYNC button  
Use to IR SYNC with the receiver (ATW-R5220/ATW-R5220DAN).
- 10** Power switch  
Use to turn the power on or off.
- 11** Battery cover
- 12** Function button  
Press to turn the screen back on if it shuts off. Press and hold to perform preselected function.
- 13** Indicator  
LED that shows the status of the transmitter.  
When the power is turned ON: Solid green  
When the transmitter is muted: Solid red

## How to insert batteries

### ATW-T5201

1. Slide the battery cover latches inward as shown by the arrows.

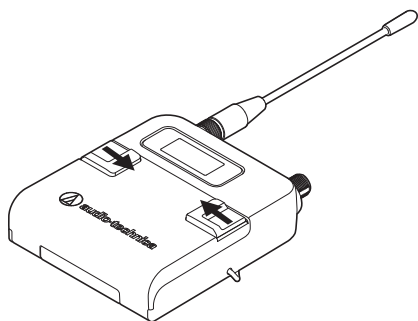

2. With the latches pressed in, slide the cover down as shown by the arrow.

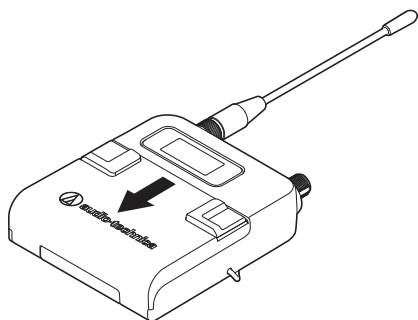

3. Open the battery cover.

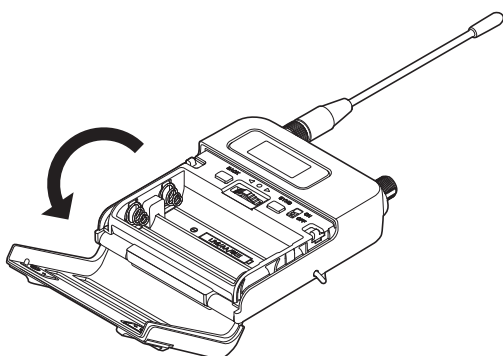

4. Insert the batteries according to the plus (+) and minus (-) marks found inside the battery compartment.

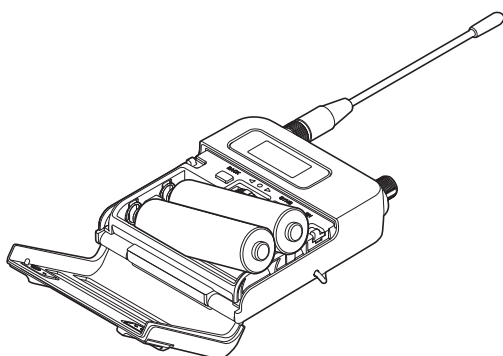

### ATW-T5202

1. Rotate the grip case of the battery compartment.

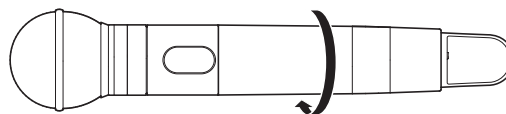

2. Open the battery cover.

- Put your finger on the hook of the battery cover and pull it to open the battery cover.

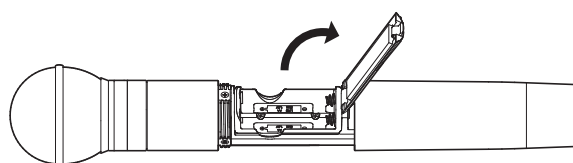

3. Insert the batteries according to the plus (+) and minus (-) marks found inside the battery compartment.

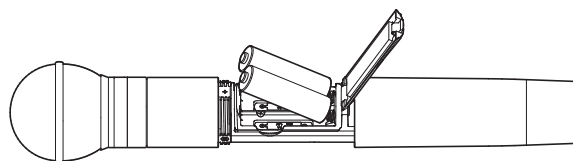

## How to attach and detach the interchangeable microphone capsule (only for ATW-T5202)

### How to attach

1. Attach the microphone capsule to the body of the transmitter.

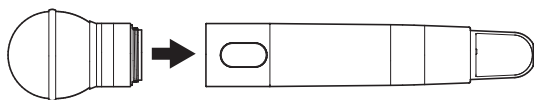

2. Rotate the microphone capsule clockwise to tighten it.

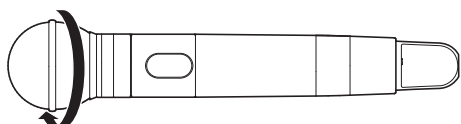

### How to remove

1. Rotate the microphone capsule counterclockwise to loosen it.

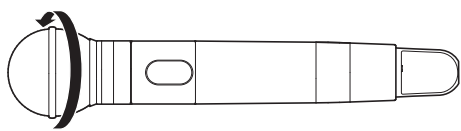

2. Detach the microphone capsule from the body of the transmitter.

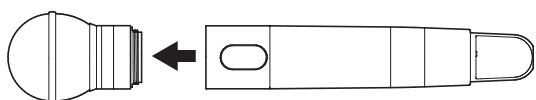

- Do not directly touch or scratch the connection surface.
- Be sure to turn off the power of the transmitter before attaching/detaching the microphone capsule.
- Do not forcibly attach the microphone capsule. Doing so may damage the transmitter or microphone capsule.

# How to read the display

## ATW-R5220/ATW-R5220DAN

### Main screen

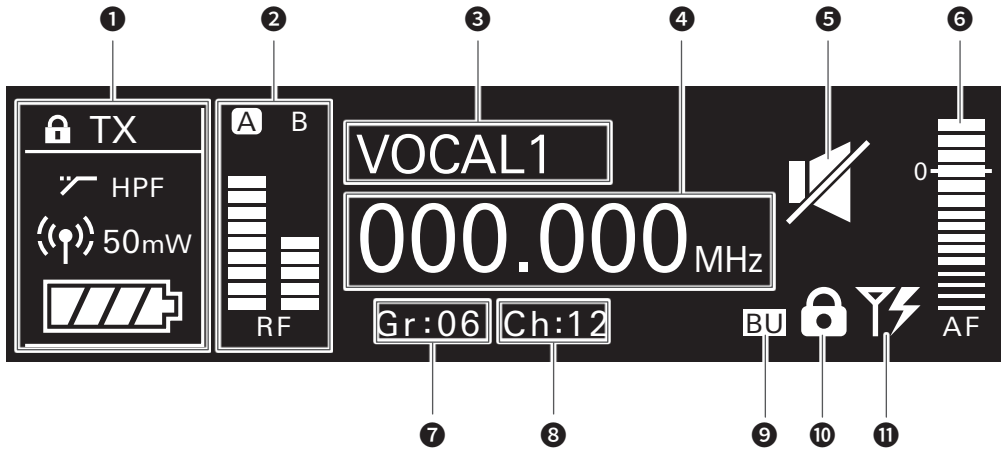

- 1** Transmitter information display area  
Information on the connected transmitter is displayed. Refer to "Transmitter information display area" (p. 11) for screen display.
- 2** RF level indicator  
Displays the strength of RF reception for antennas A and B.
- 3** Name display  
Displays the specified name.
- 4** Frequency indicator  
Displays the set frequency.
- 5** Receiver mute indicator  
A speaker icon with a slash through it is displayed when the receiver is muted.
- 6** AF level indicator  
Displays the strength of the received audio signal.
- 7** Group indicator
- 8** Channel indicator
- 9** Backup frequency indicator  
"BU" icon is displayed when the backup frequency mode is ON.
- 10** Lock status indicator
- 11** Antenna input power indicator  
An icon is displayed when the antenna input power supply is ON.

### Transmitter information display area

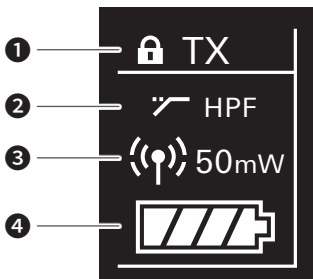

Normal

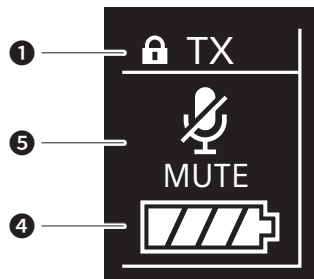

Muted

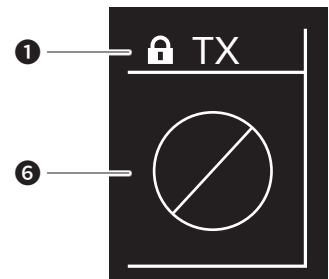

Non-communication

- 1** Lock status indicator
- 2** High-pass filter indicator
- 3** RF transmission output indicator
- 4** Battery level indicator
- 5** Transmitter mute indicator  
A microphone with a slash through it is displayed when the transmitter is muted.
- 6** Transmitter non-communication indicator

# How to read the display

## Level meter screen

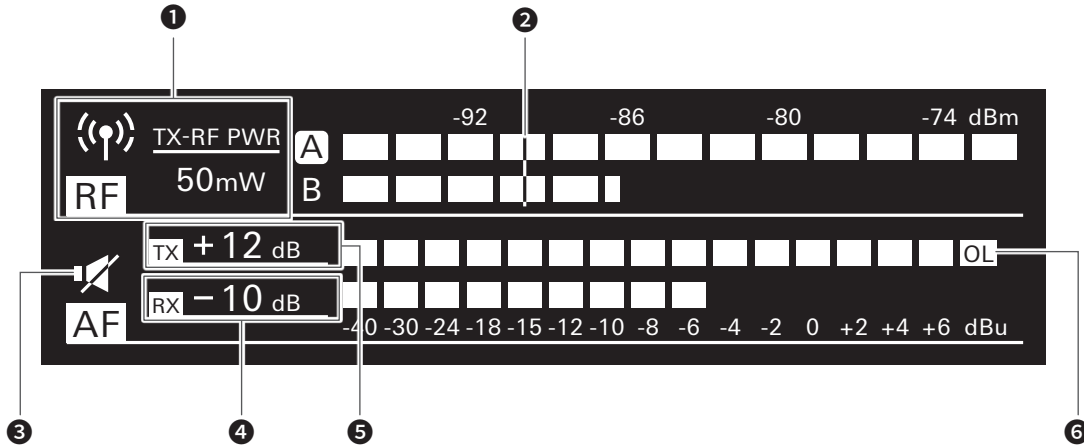

- 1** RF transmission output indicator (transmitter)
- 2** Marker (when the minimum hold function is on)  
Shows the minimum level at which the RF is held.
- 3** Mute indicator  
A speaker icon with a slash through it is displayed when transmitter is muted.
- 4** Audio output indicator (receiver)
- 5** Gain indicator (transmitter)
- 6** Overload (excessive input) indicator

## Minimum hold function

If you press the BACK button on the level meter screen, the minimum hold function turns on and its marker is displayed.

- The marker indicates the lowest level of RF signal received from the transmitter.
- The marker does not move if the input RF level is higher than the marker position.
- If the RF level input is lower than the marker position, the marker moves in tandem with the RF level.
- To reset the marker position, press the BACK button again.

## Switching between screens

The screen is switched every time the function button 1 is pressed.

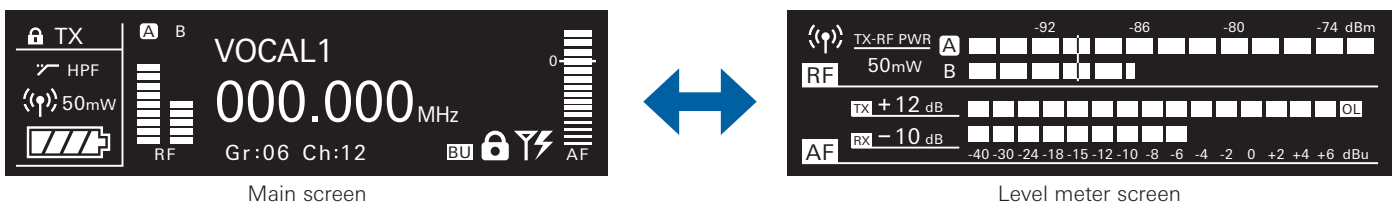

The main screen is switched every time the function button 2 is pressed.

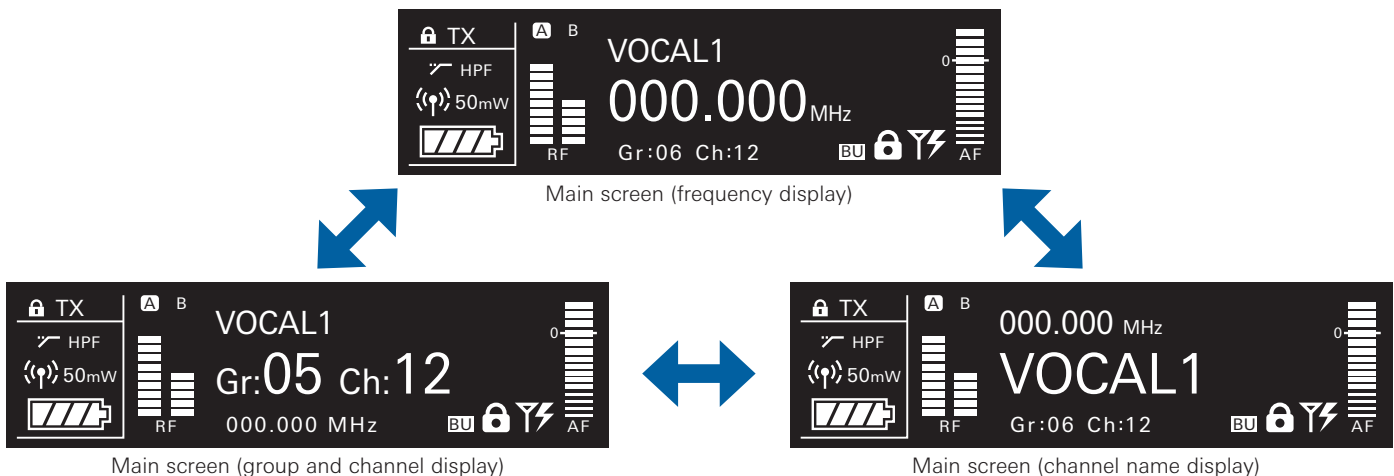

# How to read the display

## ATW-T5201/ATW-T5202



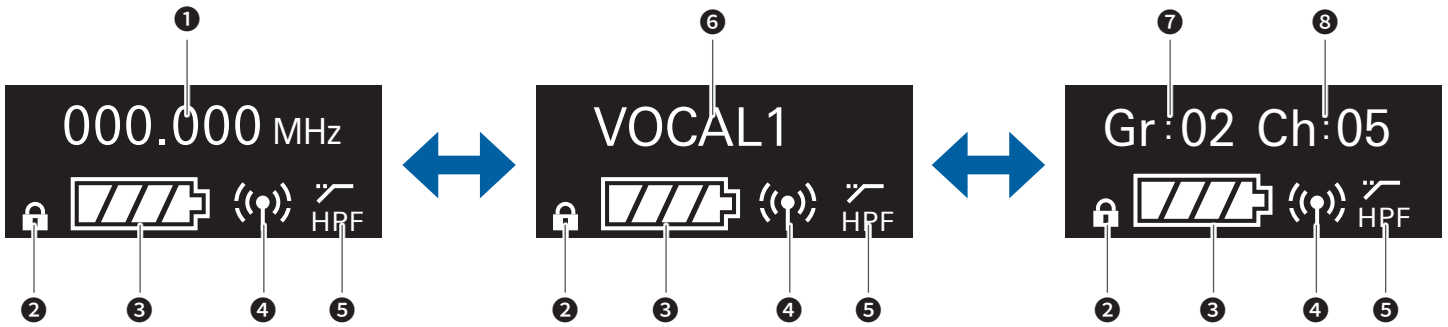

The main screen is displayed when the power is switched on. If you press the UP/Down button on the main screen, the screen display is switched.



**1** Frequency indicator  
Displays the set frequency.

**2** Lock status indicator

**3** Battery level indicator

-  : 75% or more battery power remaining.
-  : 50 to 75% battery power remaining.
-  : 25 to 50% battery power remaining.
-  : 25% or less battery power remaining.
-  (Flicker): Replace the batteries.

**4** RF transmission output indicator  
The selectable RF transmission output may differ depending on the country or region in which you live.

-  : RF Power High (50 mW)
-  : RF Power Mid (10 mW)
-  : RF Power Low (2 mW)
-  : RF Power Off

**5** High-pass filter indicator

**6** Name display  
Displays the specified name.

**7** Group indicator

**8** Channel indicator

# How to operate

## Basic operation

1. Turn on the main power button of the receiver (ATW-R5220/ATW-R5220DAN).

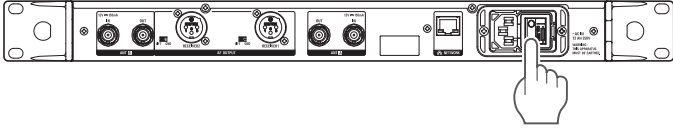

2. Turn on the power button of the receiver (ATW-R5220/ATW-R5220DAN).
  - The display lights and the main screen is displayed.

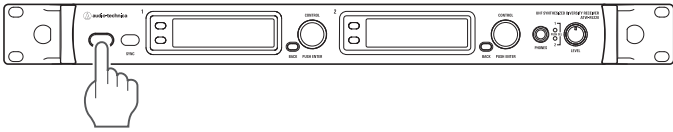

3. Set the operating frequency.
4. Turn on the power switch of the transmitter (ATW-T5201/ATW-T5202).
  - The indicator lights and the display shows the main screen.

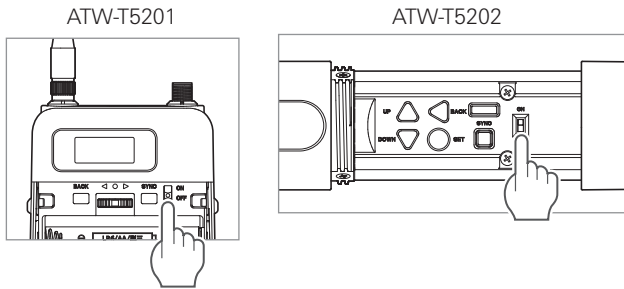

5. Set the transmission frequency.
6. Check the RF level indicator on the receiver.
  - Check that antenna A or B lights up.
7. Speak into the microphone.
  - Make sure the AF level indicator lights up on the receiver.

• Hold down the DOWN button of the transmitter (for ATW-T5201, turn the lever push switch to the DOWN side (left side) and keep it there) while turning on the power switch to start up with the RF output in the OFF state (RF OFF mode).

## Using IR SYNC

This function allows you to make settings on the receiver that are specified for the transmitter.

1. When IR SYNC is started as part of setting the receiver, the "Communication in standby" screen is displayed.
2. Position the IR SYNC windows of the receiver and transmitter so they face each other.

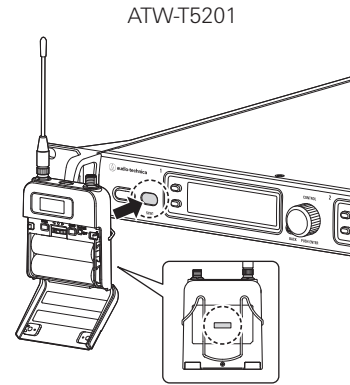

ATW-T5202

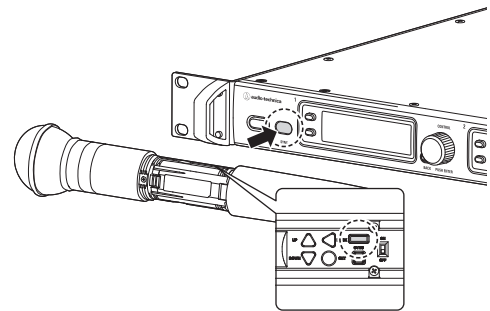

3. Press the SYNC button on the transmitter.
  - Wait several seconds until communication is established.
4. When the SYNC is complete, the "completed" screen is displayed.
  - The settings made on the receiver are automatically synced to the transmitter.
  - If an error occurs in the SYNC process, an error screen opens and then the display returns to the menu screen. Check the IR SYNC windows of the receiver and transmitter and then SYNC again.
  - To cancel the SYNC process, press the BACK button on the receiver. You will be returned to the previous screen.

## Using SYNC shortcut

SYNC shortcut allows you to easily move to the settings screen where you can configure the transmitter settings from the receiver.

1. Press and hold (for approximately 2 seconds) the control dial on the main screen.
2. "TX SYNC" setting screen is displayed.
  - Refer to "Setting transmitters via IR SYNC" (p. 17) for subsequent steps.

# Settings

Various settings can be made from the menu screen shown on the display.

## ATW-R5220/ATW-R5220DAN

1. Press the control dial.
  - The main menu screen appears.

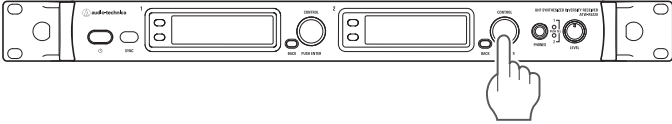

2. Turn the control dial to select the item you wish to set.



3. Press the control dial to open the settings menu of the selected item.
  - Press the BACK button to go back one screen.
  - To cancel partway through making a setting, press the BACK button.
  - While on the settings screen, the display will return to the main screen if approximately 60 seconds pass without a button or the control dial being used.

## ATW-T5201/ATW-T5202

The transmitter's (ATW-T5201/ATW-T5202) UP/DOWN button operation is explained below. While this explanation uses the UP/DOWN button operation of ATW-T5202 as its example, it can easily be applied to either transmitter.

ATW-T5201: Turn to the UP/DOWN position.  
ATW-T5202: Press the UP/DOWN button.

1. Press the SET button.
  - The menu screen appears.

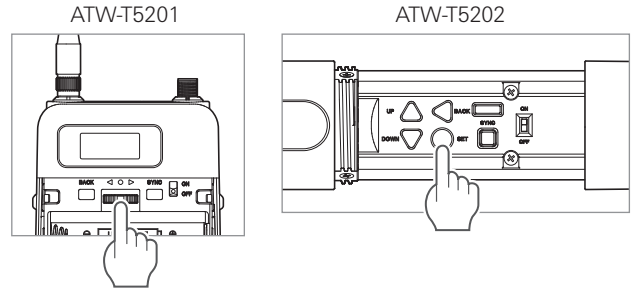

2. Press the UP/DOWN button to select the item you wish to set.

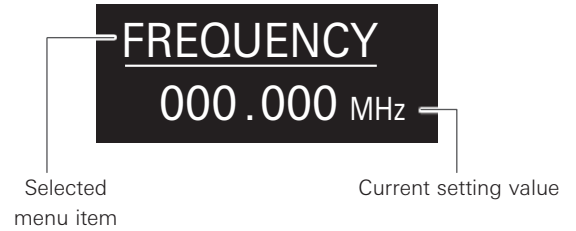

3. Press the SET button to display the settings screen for the selected item.
  - Press the BACK button to go back one screen.
  - To cancel partway through making a setting, press the BACK button.
  - While on the settings screen, the display will return to the main screen if approximately 30 seconds pass without a button being used.



# Setting ATW-R5220/ATW-R5220DAN

## List of setting items

FREQUENCY	MANUAL	Set the operating frequency.
	Gr/Ch	
NAME		Set the channel name.
AUDIO		Set the audio output level.
SCAN		Scan for open channels.
TX SYNC		Set transmitters via IR SYNC.
SQUELCH	AUTO	Set the squelch level.
	MANUAL	
UTILITIES	LOCK	Set this function to prevent the receiver settings from being changed.
	ANT PWR	Set whether to turn power on or off to the antenna input terminals.
	Gr/Ch EDIT	Edit the groups/channels 01 to 10.
	BACKUP FREQ	Set the backup frequency.
	AF METER	Switch the level meter on the main screen between receiver and transmitter.
	BRIGHTNESS	Set the display brightness.
	ACCESS	Set the user access level.
	RESET	This returns the receiver settings to their factory defaults.
	VERSION	This function displays product information such as the version of the receiver.
NETWORK	DEVICE ID	Set the receiver's ID No.
	IP SETTING	Set the IP.
	REMOTE CTRL	Set the remote control.
	SYSLOG	Set whether to send the log message to the Syslog server.
	DISCOVERY	Set automatic detection by the application.
	NTP	Set the NTP (Network Time Protocol).
	MAC ADDRESS	Display the MAC address.
TOOLS	WALK TEST	Record the RF level being received for 90 seconds.
	MONITOR MODE	This mode will enable monitoring with headphones only. (The audio OUT and DANTE OUT will be muted.)
DANTE*	INFO	Display the device name and channel label.
	IP SETTING	Set the DANTE's IP.
	MAC ADDRESS	Display the MAC address.
	VERSION	This function displays product information, such as the version of the DANTE.

\* ATW-R5220DAN only

## Setting the operating frequency

### Manual setting

- From the menu screen, turn the control dial, select [FREQUENCY] and then press the control dial.
- Select [MANUAL] and press the control dial.
- Turn the control dial to set the first 3 digits. When finished setting them, press the control dial.
  - Set it in the order of the top 2 digits, top 1 digit.
- Turn the control dial to set the last 3 digits. When finished setting them, press the control dial.
  - The setting is complete.

### Setting by group/channel

- From the menu screen, turn the control dial, select [FREQUENCY] and then press the control dial.
- Select [Gr/Ch] and press the control dial.
- Turn the control dial to set the group. When finished setting it, press the control dial.
- Turn the control dial to set the channel. When finished setting it, press the control dial.
  - The setting is complete.

## Setting the channel (receiver) name

The following characters can be entered:

- The maximum number of characters that can be entered is 8.

Alphabetic (uppercase letters)	Numeric
Symbols (., +, -, #, &, period)	Space

- From the menu screen, turn the control dial, select [NAME] and then press the control dial.
- Turn the control dial, select the desired character and then press the control dial.
  - The character is input and the cursor moves.
- Repeat the operation in Step 2 to enter all characters.
- Turn the control dial, select [End] and then press the control dial.
  - The setting is complete.

# Setting ATW-R5220/ATW-R5220DAN

## Setting the audio output level

1. From the menu screen, turn the control dial, select [AUDIO] and then press the control dial.
2. Turn the control dial to set the audio output level.
  - The level changes +/- 2 dB each time you turn the control dial.
  - It can be set from -60 to 0 dB.
3. Press the control dial.
  - The setting is complete.

## Scanning for open channels

Scan for unused channels in the current environment for use.

1. From the menu screen, turn the control dial, select [SCAN] and then press the control dial.
2. Turn the control dial to select the group you want to scan. After selecting a group, press the control dial.
  - Selecting "ALL" will scan all the groups.
3. Turn the control dial to select the preferred threshold. After selecting the threshold, press the control dial.
  - You can select [Normal], [High] or [Low] sensitivity.

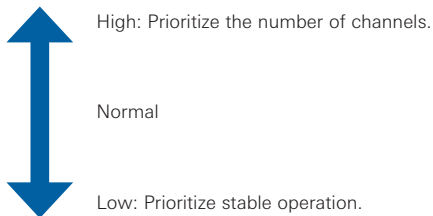

- Scan starts.

### Selecting [ALL]:

4. Confirm the scan result, select the group and then press the control dial.
5. Select the channel selection method, and then press the control dial.
  - When selecting [Manual] and pressing the control dial, available channels and frequencies are shown in a list. Turn the control dial, select an available channel and then press the control dial. The setting is complete.
  - When selecting [Find Best] and pressing the control dial, the optimum channel and frequency are shown. Turn the control dial, select [Set] and then press the control dial. The setting is complete.

### Selecting the group you want to scan:

4. Confirm the scan result by selecting [OK] and then pressing the control dial.
  - If you want to scan over again, select [Retry].
5. Select the channel selection method, and then press the control dial.
  - When selecting [Manual] and pressing the control dial, available channels and frequencies are shown in a list. Turn the control dial, select an available channel and then press the control dial. The setting is complete.
  - When selecting [Find Best] and pressing the control dial, the optimum channel and frequency are shown. Turn the control dial, select [Set] and then press the control dial. The setting is complete.

## Setting transmitters via IR SYNC

This function allows you to make transmitter settings on the receiver and then automatically configure the transmitter via IR SYNC. The following are the available settings and setting values:

Settings	Setting values
Freq	Current setting value, NoChange
Name	Current setting value, NoChange
RF Pwr*1	Low:2mW, Mid:10mW, High:50mW, NoChange
Gain	-10 to +20dB, NoChange
Sens.*2	0, +10dB, NoChange
Lock	Lock, Unlock, NoChange
Batt	Alkaline, Ni-MH, NoChange
HPF	OFF, ON, NoChange

\*1 The selectable RF transmission output may differ depending on the country or region in which you live.

\*2 ATW-T5201 only

1. From the menu screen, turn the control dial, select [TX SYNC] and then press the control dial.
2. Turn the control dial to select a setting you would like to sync to the transmitter and then press the control dial.
3. Turn the control dial to select the setting value and then press the control dial.
4. Repeat Steps 2 and 3 for each setting you would like to sync to the transmitter.
5. Turn the control dial, select [SYNC START] and then press the control dial.
  - Communication function is in standby. Refer to "Using IR SYNC" (p. 14) for subsequent steps.

- This setting can also be displayed by pressing and holding (for about 2 seconds) the control dial on the receiver while on the Main screen.

# Setting ATW-R5220/ATW-R5220DAN

## Setting the squelch level

### Setting automatically

1. From the menu screen, turn the control dial, select [SQUELCH] and then press the control dial.
2. Turn the control dial, select [AUTO] and then press the control dial.
3. Turn the control dial, select [Normal], [High] or [Low] and then press the control dial.

- You can select one from [Normal], [High] or [Low].



High: Prioritize the sound/voice quality.

Normal

Low: Prioritize the available range.

- Scan starts.
  - If an error message is displayed, change the operating frequency. The error indicates that the current frequency is already in use or that there is excessive noise.
4. Scan starts. Press the control dial.
    - The setting is complete.

### Setting manually

1. From the menu screen, turn the control dial, select [SQUELCH] and then press the control dial.
2. Turn the control dial, select [MANUAL] and then press the control dial.
3. Turn the control dial to select the value you wish to set.
  - The meter indicates the RF level.
  - It can be set from levels 1 to 16 or be set to OFF. A loud noise could be produced when setting to OFF, depending on the electromagnetic wave state, so be careful when using this.
  - While the available range of the transmitter becomes wider as the squelch level is lower, there may be cases when noises occur under the influence of other radio waves. While the available range of the transmitter becomes narrower as the squelch level is made higher, noises are less likely to occur due to the decreased influence of other radio waves.
4. Press the control dial.
  - The setting is complete.

## Setting the system-related functions

### Setting the lock

Set this function to prevent the receiver settings from being changed.

- The default setting is [Unlock].
1. From the menu screen, turn the control dial, select [UTILITIES] and then press the control dial.
  2. Turn the control dial, select [LOCK] and then press the control dial.
  3. Turn the control dial to select [Lock] or [Unlock], and then press the control dial.
    - The setting is complete.

### Setting the antenna power

Set whether to turn power on or off to the antenna input terminals.

- The default setting is [OFF].
  - If set to [ON], power is supplied to both antennas A and B.
1. From the menu screen, turn the control dial, select [UTILITIES] and then press the control dial.
  2. Turn the control dial, select [ANT PWR] and then press the control dial.
  3. Turn the control dial, select [ON] or [OFF] and then press the control dial.
    - The setting is complete.

# Setting ATW-R5220/ATW-R5220DAN

## Setting group/channel editing

### Setting group/channel

Groups/Channels 01 to 10 can be edited.

- All channels are vacant in the initial state.

1. From the menu screen, turn the control dial, select [UTILITIES] and then press the control dial.
2. Turn the control dial, select [Gr/Ch EDIT] and then press the control dial.
3. Turn the control dial, select [EDIT] and then press the control dial.
4. Turn the control dial, select a group and then press the control dial.
5. Turn the control dial, select [ON] or [OFF] and then press the control dial.
  - If you select [OFF], the group cannot be used.
6. Turn the control dial, select a channel and then press the control dial.
7. Turn the control dial, select [SET] or [RESET] and then press the control dial.
  - By pressing [SET], you can set the frequency of the selected channel.
  - If you press [RESET], the frequency of the selected channel becomes blank.
8. After setting all channels, turn the control dial, select [Sync] or [Save] and then press the control dial.
  - If you press [Save], the setting is completed.
  - If you press [Sync], the screen turns to an IR SYNC standby screen. Refer to "Using IR SYNC" (p. 14) for subsequent steps.

### Syncing the Group/Channel

The Groups/Channels that have been set with [EDIT] can be set to the transmitter in groups with IR SYNC.

1. From the menu screen, turn the control dial, select [UTILITIES] and then press the control dial.
2. Turn the control dial, select [Gr/Ch EDIT] and then press the control dial.
3. Turn the control dial, select [Gr/Ch SYNC] and then press the control dial.
4. Turn the control dial to select group and then press the control dial.
  - The screen turns to an IR SYNC standby screen. Refer to "Using IR SYNC" (p. 14) for subsequent steps.

## Setting the backup frequency mode

If you set the backup frequency in advance, you can switch the frequency of the transmitter and receiver with the transmitter. It is convenient to set this function when you want to switch the frequency easily.

- The default setting is [OFF].
1. From the menu screen, turn the control dial, select [UTILITIES] and then press the control dial.
  2. Turn the control dial, select [BACKUP FREQ] and then press the control dial.
  3. Turn the control dial, select [ON] and then press the control dial.
  4. Turn the control dial, select [Manual] or [Gr/Ch] and then press the control dial.
    - If you select [Manual], you can set the frequency.
    - If you select [Gr/Ch], you can set the group/channel.
  5. After setting each item, turn the control dial, select [Set] or [Sync] and then press the control dial.
    - If you press [Set], the setting is completed but you must still sync the setting with the transmitter or set the backup frequency manually on the transmitter in order to use the backup frequency.
    - If you press [Sync], the screen turns to an IR SYNC standby screen. Refer to "Using IR SYNC" (p. 14) for subsequent steps.

# Setting ATW-R5220/ATW-R5220DAN

## Setting the AF level meter on the main screen

Switch the AF level meter on the main screen between [Receiver (RX)] and [Transmitter (TX)].

- The default setting is [RX].
1. From the menu screen, turn the control dial, select [UTILITIES] and then press the control dial.
  2. Turn the control dial, select [AF METER] and then press the control dial.
  3. Turn the control dial, select [RX] or [TX] and then press the control dial.
    - The setting is complete.

## Setting the display brightness

The default setting is [High].

1. From the menu screen, turn the control dial, select [UTILITIES] and then press the control dial.
2. Turn the control dial, select [BRIGHTNESS] and then press the control dial.
3. Turn the control dial, select [High] or [Low] and then press the control dial.
  - The setting is complete.

## Setting the user access level

Set the user access level.

- The default setting is [Free Tuning].
1. From the menu screen, turn the control dial, select [UTILITIES] and then press the control dial.
  2. Turn the control dial, select [ACCESS] and then press the control dial.
  3. Turn the control dial, select [Free Tuning] or [Group Only] and then press the control dial.

Free Tuning	No limit
Group Only	Selection of frequency can be made only from group.

- The setting is complete.

## Resetting

This returns the receiver settings to their factory defaults.

1. From the menu screen, turn the control dial, select [UTILITIES] and then press the control dial.
2. Turn the control dial, select [RESET] and then press the control dial.
3. Turn the control dial, select [Yes] and then press the control dial.
4. After the confirmation screen is displayed, turn the control dial again to select [Yes] and then press the control dial.
  - Reset starts.

## Checking the version of the receiver

This function displays product information such as the version of the receiver.

1. From the menu screen, turn the control dial, select [UTILITIES] and then press the control dial.
2. Turn the control dial, select [VERSION].

# Setting ATW-R5220/ATW-R5220DAN

## Setting network

By connecting the receiver and PC, you can use the dedicated app for monitoring or controlling with the PC.

### Setting the receiver's ID No.

1. From the menu screen, turn the control dial, select [NETWORK] and then press the control dial.
2. Turn the control dial, select [DEVICE ID] and then press the control dial.
3. Turn the control dial, select the device ID and then press the control dial.
  - The setting is complete.

### Setting the IP

1. From the menu screen, turn the control dial, select [NETWORK] and then press the control dial.
2. Turn the control dial, select [IP SETTING] and then press the control dial.
3. Select an item you want to set and press the control dial.

IP Mode	Set how to obtain IP addresses. [Auto]: IP addresses are automatically assigned. [Static]: Set to use the specified static IP addresses.
IP Address*	Specify static IP addresses.
Subnet Mask*	Set the subnet mask.
Gateway*	Set the gateway.

\*This item can be set only when [IP Mode] is set to [Static].

4. Set each item.

### Setting the remote control

1. From the menu screen, turn the control dial, select [NETWORK] and then press the control dial.
2. Turn the control dial, select [REMOTE CTRL] and then press the control dial.
3. Select an item you want to set and press the control dial.

Port	Set the IP port number.
Notification	Receive notifications from the receiver.
LVL Notify*	Set whether to include the AF and RF level in the notification from the receiver during remote control.
Multicast IP*	Set the address for multicast.
Multicast Port*	Set the port number for multicast.

\*This item can be set only when [Notification] is set to [ON].

4. Set each item.

### Setting the log message

Set whether to send the log message to the Syslog server.

1. From the menu screen, turn the control dial, select [NETWORK] and then press the control dial.
2. Turn the control dial, select [SYSLOG] and then press the control dial.
3. Turn the control dial, select [ON] or [OFF] and then press the control dial.
  - The setting is complete.

• Syslog is a standard for transferring log messages across IP networks. It is used for administration of computer systems and security monitoring.

### Setting automatic detection by the application

1. From the menu screen, turn the control dial, select [NETWORK] and then press the control dial.
2. Turn the control dial, select [DISCOVERY] and then press the control dial.
3. Turn the control dial, select [ON] or [OFF] and then press the control dial.
  - The setting is complete.

### Setting NTP

Set the NTP (Network Time Protocol).

1. From the menu screen, turn the control dial, select [NETWORK] and then press the control dial.
2. Turn the control dial, select [NTP] and then press the control dial.
3. Select an item you want to set and press the control dial.

NTP	Set whether to enable or disable the NTP (Network Time Protocol).
Server adrs*	Set the NTP server address.
Port*	Set the NTP port number.
Time Zone*	Set the time difference from the UTC (Coordinated Universal Time).
DST*	Turn on/off the daylight saving time.
DST Start Date*	Set the starting date of daylight saving time.
DST Start Time*	Set the starting time of daylight saving time.
DST End Date*	Set the ending date of daylight saving time.
DST End Time*	Set the ending time of daylight saving time.

\*This item can be set only when [NTP] is set to [ON].

4. Set each item.

# Setting ATW-R5220/ATW-R5220DAN

## Setting MAC address

1. From the menu screen, turn the control dial, select [NETWORK] and then press the control dial.
2. Turn the control dial, select [MAC ADDRESS].

## Using test tool

### Using the walk test function

The walk test function records the RF level being received for 90 seconds.

1. From the menu screen, turn the control dial, select [TOOLS] and then press the control dial.
2. Turn the control dial, select [WALK TEST] and then press the control dial.
3. Select [START] and press the control dial.
  - Walk test starts.

### Setting monitor mode

This mode will enable monitoring with headphones only. (The audio OUT and DANTE OUT will be muted.)

1. From the menu screen, turn the control dial, select [TOOLS] and then press the control dial.
2. Turn the control dial, select [MONITOR MODE] and then press the control dial.
  - Monitor mode is set.

## Setting DANTE

This setting is used only for ATW-R5220DAN.

### Displaying the device name and channel label

1. From the menu screen, turn the control dial, select [DANTE] and then press the control dial.
2. Turn the control dial, select [INFO].

## Setting the DANTE's IP

1. From the menu screen, turn the control dial, select [DANTE] and then press the control dial.
2. Turn the control dial, select [IP SETTING] and then press the control dial.
3. Select an item you want to set and press the control dial.

IP Mode	Set how to obtain IP addresses. [Auto]: IP addresses are automatically assigned. [Static]: Set to use the specified static IP addresses.
IP Address*	Specify static IP addresses.
Subnet Mask*	Set the subnet mask.
Gateway*	Set the gateway.

\*This item can be set only when [IP Mode] is set to [Static].

4. Set each item.

### Setting MAC address

1. From the menu screen, turn the control dial, select [DANTE] and then press the control dial.
2. Turn the control dial, select [MAC ADDRESS].

### Checking the version of the DANTE

This function displays product information such as the version of the DANTE.

1. From the menu screen, turn the control dial, select [DANTE] and then press the control dial.
2. Turn the control dial, select [VERSION].

# Setting ATW-T5201/ATW-T5202

## List of setting items

FREQUENCY	MANUAL	Set the transmission frequency.
	Gr/Ch	
NAME		Set the channel name.
GAIN		Set the microphone input gain.
SENSITIVITY*		Select the microphone input gain from 0 dB/+10 dB.
RF POWER		Set the transmission output.
HPF		Set HPF (High-Pass Filter).
LOCK		Set a lock.
TOOLS	Fn BUTTON	Set the function allocation for function button.
	TEST TONE	Output a test signal from the transmitter.
UTILITIES	BATTERY	Set the type of batteries used.
	LED	Set whether to constantly keep indicator turned on or off.
	ACCESS	Set the user access level.
	RESET	This returns the transmitter settings to their factory defaults.
	VERSION	It shows the version of the transmitter.

\* ATW-T5201 only

## Setting the transmission frequency

### Setting manually

- From the menu screen, press the UP/DOWN button to select [FREQUENCY], and then press the SET button.

**FREQUENCY**  
000.000 MHz

- After selecting [MANUAL], press the SET button.

**FREQUENCY**  
**MANUAL**

- Press the UP/DOWN button to set the first 3 digits. After completing the setting, press the SET button.
- Press the UP/DOWN button to set the last 3 digits. After completing the setting, press the SET button.
  - The setting is complete.

### Setting by group/channel

- From the menu screen, press the UP/DOWN button to select [FREQUENCY], and then press the SET button.

**FREQUENCY**  
000.000 MHz

- After selecting [Gr/Ch], press the SET button.

**FREQUENCY**  
**Gr/Ch**

- Press the UP/DOWN button to set the group. After completing the setting, press the SET button.
- Press the UP/DOWN button to set the channel. After completing the setting, press the SET button.
  - The setting is complete.

## Setting the channel (transmitter) name

The following characters can be entered:

- The maximum number of characters that can be entered is 8.

Alphabetic (uppercase letters)	Numeric
Symbols (., +, -, #, &, period)	Space

- From the menu screen, press the UP/DOWN button to select [NAME], and then press the SET button.

**NAME**

- Press the UP/DOWN to select a desired character and press the SET button.
  - The character is input and the cursor moves.
- Repeat the operation in Step 2 to enter all characters.
  - If you don't enter 8 characters, press the UP/DOWN button and select [End] and then press the SET button.
- After entering the 8th character, press the SET button.
  - [End] is displayed.
- Press the SET button.
  - The setting is complete.



## Setting ATW-T5201/ATW-T5202

### Setting the microphone input gain

1. From the menu screen, press the UP/DOWN button to select [GAIN], and then press the SET button.



2. Press the UP/DOWN button to select the gain you wish to set.
  - The level changes +/- 2 dB each time you press the UP/DOWN button.
  - It can be set from -10 to +20 dB.
3. Press the SET button.
  - The setting is complete.

### Selecting the microphone input gain

1. From the menu screen, press the UP/DOWN button to select [SENSITIVITY], and then press the SET button.



2. Press the UP/DOWN button and select [0dB] or [+10dB].
3. Press the SET button.
  - The setting is complete.

### Setting the RF transmission output

The selectable RF transmission output may differ depending on the country or region in which you live.

1. From the menu screen, press the UP/DOWN button to select [RF POWER], and then press the SET button.



2. Press the UP/DOWN button and select [High:50mW], [Mid:10mW], [Low:2mW] or [Off].
3. Press the SET button.
  - The setting is complete.

### Setting HPF (High-Pass Filter)

1. From the menu screen, press the UP/DOWN button to select [HPF], and then press the SET button.



2. Press the UP/DOWN button to select [On] or [Off].
3. Press the SET button.
  - The setting is complete.

### Setting lock

1. From the menu screen, press the UP/DOWN button to select [LOCK], and then press the SET button.



2. Press the UP/DOWN button to select [Lock] or [Unlock].

Lock	Locks transmitter buttons
Unlock	Unlocks transmitter buttons

3. Press the SET button.
  - The setting is complete.

# Setting ATW-T5201/ATW-T5202

## Setting the function

### Setting the function for the function button

Select the function to be performed when the function button is pressed and held

1. From the menu screen, press the UP/DOWN button to select [TOOLS], and then press the SET button.

TOOLS

2. Press the UP/DOWN button to select [Fn BUTTON], and then press the SET button.

Fn BUTTON  
Disable

3. Press the UP/DOWN button to select the function you wish to set.

Disable	No function.
Mute	Mutes the transmitter.
MuteOnLock	Mutes the transmitter (even when transmitter buttons are locked).
Bkup Freq	Switches to backup frequency. (When selected, set the frequency, group, and channel.)
RF Off	Turns off RF transmission output.

4. Press the SET button.
  - The setting is complete.

### Outputting a test signal from the transmitter

1. From the menu screen, press the UP/DOWN button to select [TOOLS], and then press the SET button.

TOOLS

2. Press the UP/DOWN button to select [TEST TONE], and then press the SET button.

TEST TONE  
Off

3. Press the UP/DOWN button to select [On], and then press the SET button.
  - A 440 Hz test signal is output as the audio signal in place of the microphone input.
  - While outputting a test signal, a microphone input will be muted.

## Setting the system-related functions

### Setting the battery type

Set the type of batteries used.

- The default setting is [Alkaline].

1. From the menu screen, press the UP/DOWN button to select [UTILITIES], and then press the SET button.

UTILITIES

2. Press the UP/DOWN button to select [BATTERY] and press the SET button.

BATTERY  
Alkaline

3. Press the UP/DOWN button to select the battery you wish to set.

Alkaline	Select when using alkaline batteries.
NiMH	Select when using nickel-metal hydride batteries.

4. Press the SET button.
  - The setting is complete.

• If the appropriate setting is not made for the batteries used, the battery power indicator will not display the correct information. Always set the type of battery according to the batteries used.

# Setting ATW-T5201/ATW-T5202

## Setting the indicator

The indicator LED can be turned [On] or [Off].

- The default setting is [On].
1. From the menu screen, press the UP/DOWN button to select [UTILITIES], and then press the SET button.



2. Press the UP/DOWN button to select [LED] and press the SET button.



3. Press the UP/DOWN button to select [On] or [Off].
4. Press the SET button.
  - The setting is complete.

## Setting the user access level

Set the user access level.

- The default setting is [Free].
1. From the menu screen, press the UP/DOWN button to select [UTILITIES], and then press the SET button.



2. Press the UP/DOWN button to select [ACCESS] and press the SET button.



3. Press the UP/DOWN button to select [Free] or [Group].

Free	No limit.
Group	Selection of frequency can be made only from group.

4. Press the SET button.
  - The setting is complete.

## Resetting

This returns the transmitter settings to their factory defaults.

1. From the menu screen, press the UP/DOWN button to select [UTILITIES], and then press the SET button.



2. Press the UP/DOWN button to select [RESET] and press the SET button.



3. Press the UP/DOWN button to select [Yes].
4. When the confirmation screen is shown, press the UP/DOWN button again to select [Yes].
5. Press the SET button.
  - Reset starts.

## Checking the transmitter information

This function displays the firmware version for the transmitter.

1. From the menu screen, press the UP/DOWN button to select [UTILITIES], and then press the SET button.



2. Press the UP/DOWN button to select [VERSION] and press the SET button.
  - The version is shown.



## How to attach the transmitter (ATW-T5201)

The ATW-T5201 transmitter is equipped with a clip that can be used to attach the transmitter to a belt, etc.

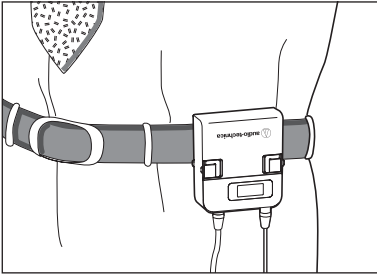

You can reverse the direction of the input connector by attaching the clip in the opposite direction.

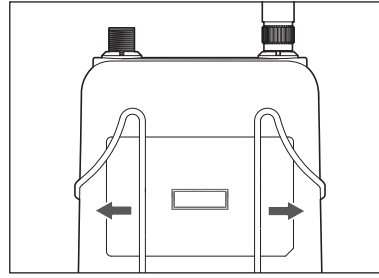

Pull both sides of the clip firmly to the outside to remove the clip from the transmitter.

## Making connections (basic connections)

This is an example of connections made when using one receiver.

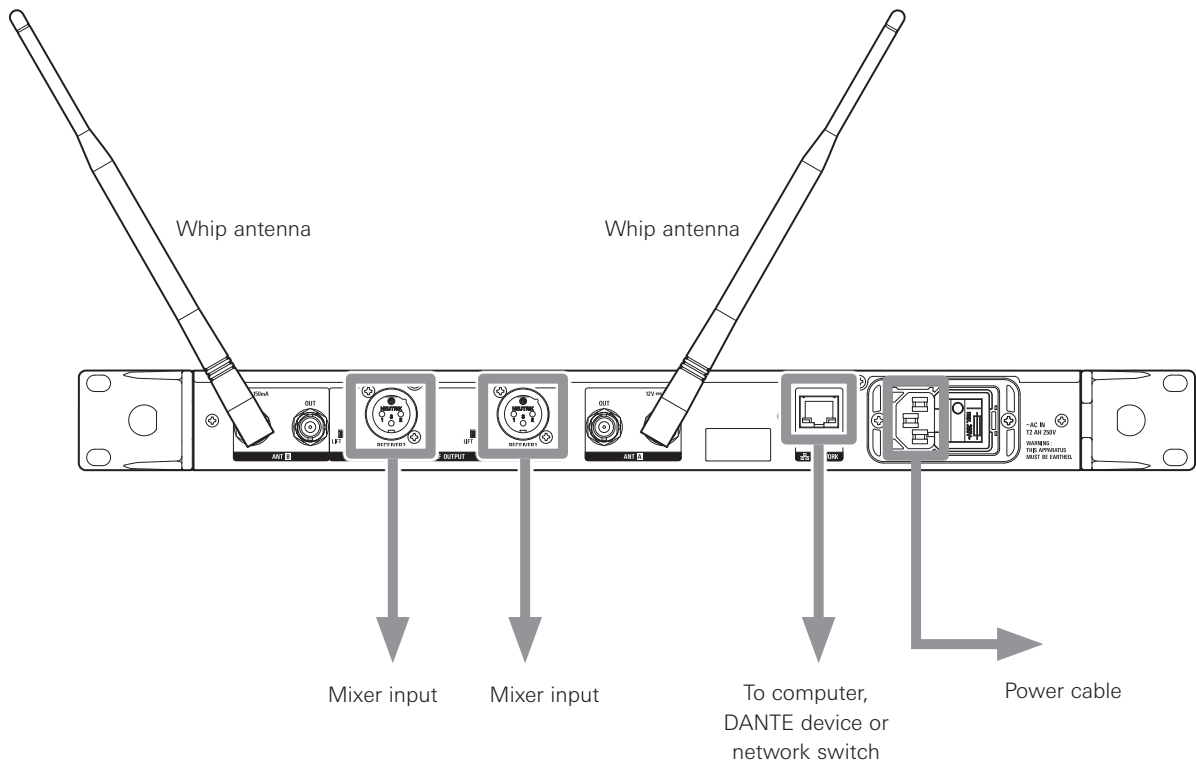

## Making connections (cascade connections)

Using the antenna output jack makes it possible to connect an additional 7 receivers (for a total of 8) in a cascade connection without using an antenna divider.

- When cascading receivers, connect either the included whip antennas or external antennas to the main receiver's antenna input jacks, and then, cascade each receiver via BNC cable.

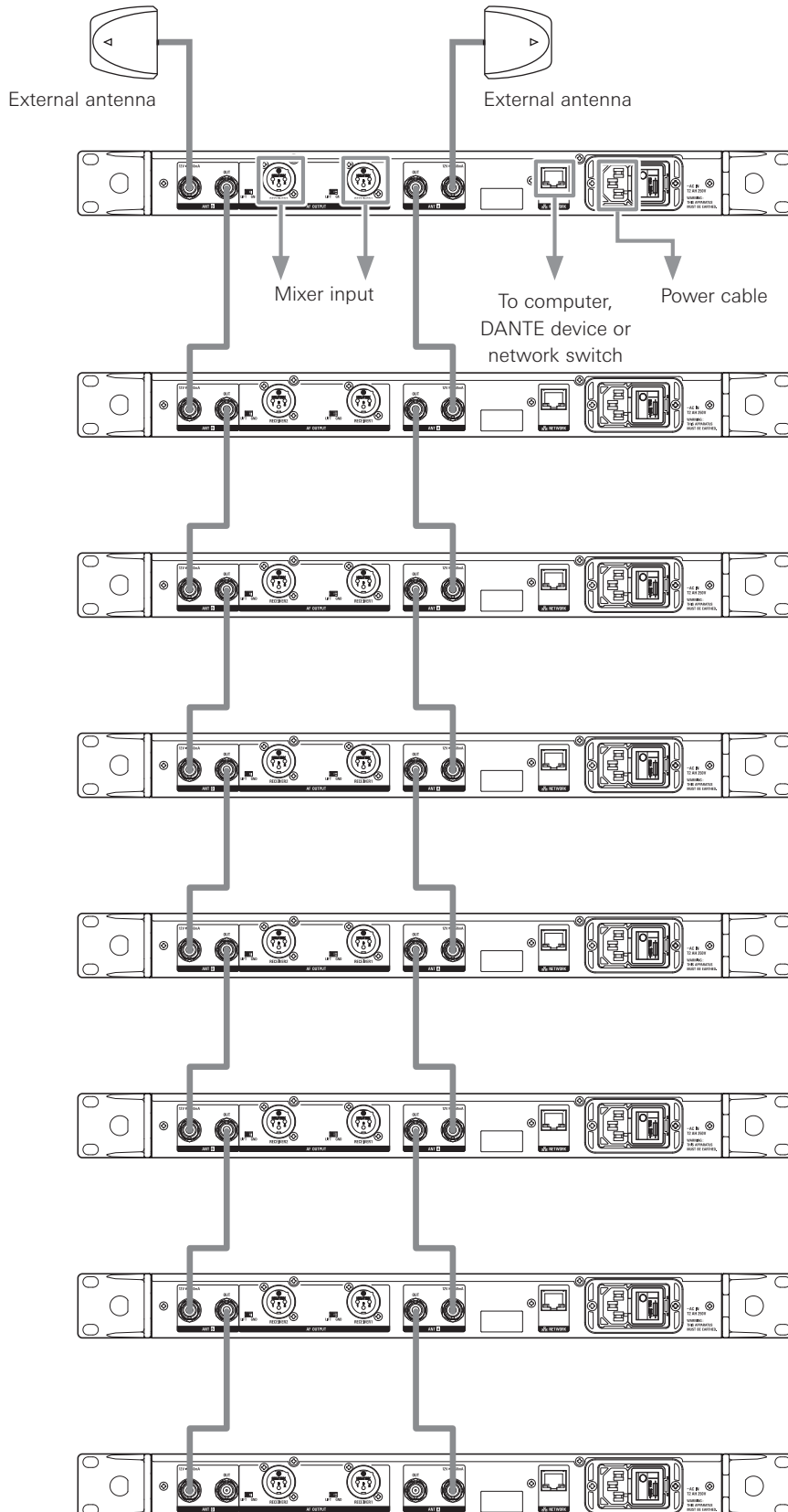

---

## Achieving stable reception

---

Low RF signal may result if there are obstructions between receiver antennas and transmitter(s). In such a case, reposition the antennas to get better reception. Use external antennas (sold separately) if the installation space is limited.

---

## Rack-mounting the receiver

---

- Screws for rack-mounting the receiver are not included.
- Consider ventilation when rack-mounting to avoid heat building up in the rack.
- When installing the product on a rack, make sure that the temperature inside the rack does not reach or exceed 45°C. Higher temperatures may negatively affect the internal parts of the product, causing the product to malfunction.
- Ensure at least a 10-millimeter space between the product and other devices or the top and side faces of the rack.
- Do not place any objects around the rear of this apparatus to ensure proper ventilation of this apparatus.
- The required rack specifications are as follows:
  - EIA-standard 19-inch rack
  - 1U-size attachable rack
  - Rack with a shelf on which the product is placed or a guide rail that supports the product

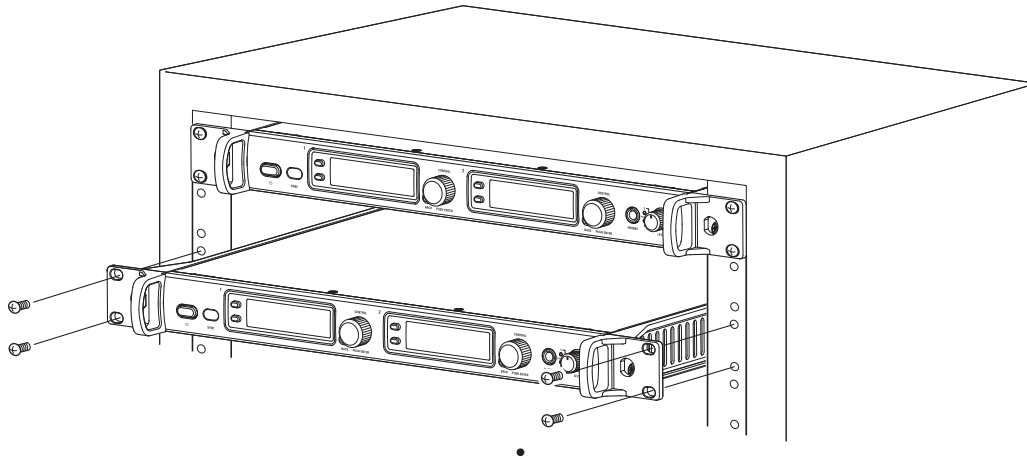

## Troubleshooting

### ATW-R5220/ATW-R5220DAN

Symptoms	Causes and countermeasures	Reference page
The power can't be turned on.	Confirm that the power cable is correctly connected.	-
There is no voice output. The voice output level is low.	Confirm that the transmitter/receiver channels are correct	p. 16, p. 23
	Confirm that the power buttons of the transmitter/receiver are not turned OFF.	p. 14
	Confirm that the antennas are correctly connected.	-
	Confirm that all connected components, such as a mixer, are correctly connected to the receiver.	-
	Confirm that the audio output isn't set to the minimum level.	p. 17
	Confirm that the audio output level of connected components (such as a mixer) is not minimized.	-
Sound is distorted.	Confirm that the audio output level isn't too high.	p. 17
	Confirm that the volume of any connected component isn't too high.	-
There is unwanted noise.	Confirm that there is no noise source, such as a fluorescent lamp or electric component, near the receiver.	-
	Confirm that each transmitter is using a different frequency.	-
	Confirm that the output terminal of the receiver is correctly connected.	p. 27
	Confirm that the receiver isn't taking power from an electrical outlet that is also being used by another noisy component.	-
	Confirm that there isn't any other nearby wireless system using the same frequency band. Adjust the squelch level.	p. 18

### ATW-T5201/ATW-T5202

Symptoms	Causes and countermeasures	Reference page
The power can't be turned on.	Confirm that batteries are in place.	-
	Confirm that batteries are not depleted.	-
	Confirm that batteries are inserted in the right direction.	p. 9
There is no voice output. The voice output level is low.	Confirm that the transmitter/receiver channels are correct	p. 16, p. 23
	Confirm that the power switch is not turned OFF.	p. 14
	Confirm that RF Power isn't OFF.	p. 24
	Confirm that the transmitter isn't in mute mode.	p. 25
	Confirm that the transmission output of the transmitter is not too low.	p. 24
	Confirm that the microphone or the guitar cable is not disconnected (only for ATW-T5201).	-
	Confirm that the output volume of the musical instrument, such as a guitar, isn't set at the minimum level.	-
	Confirm that the microphone capsule is connected properly (only for ATW-T5202).	p. 10
Sound is distorted.	Confirm that the gain setting of the transmitter is not too high.	p. 24
There is unwanted noise.	Confirm that there is no noise source, such as a fluorescent lamp, LED lamp, or electric component, near the transmitter.	-
	Confirm that each transmitter is using a different frequency.	-
	Confirm that the transmission output setting of the transmitter is not too high.	p. 24

# Dimensions

## ATW-R5220/ATW-R5220DAN

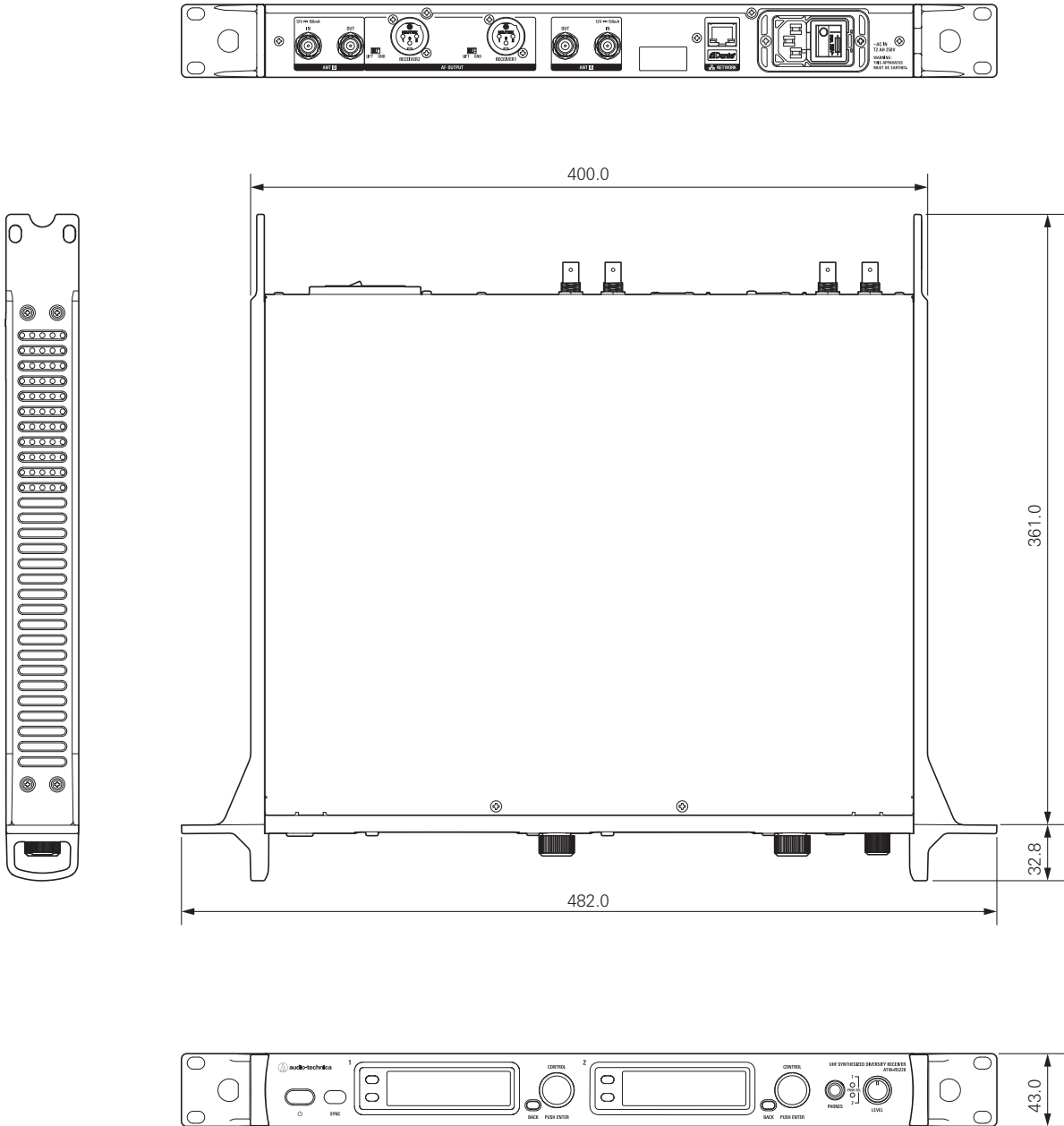

(Unit: mm)



## Dimensions

### ATW-T5201

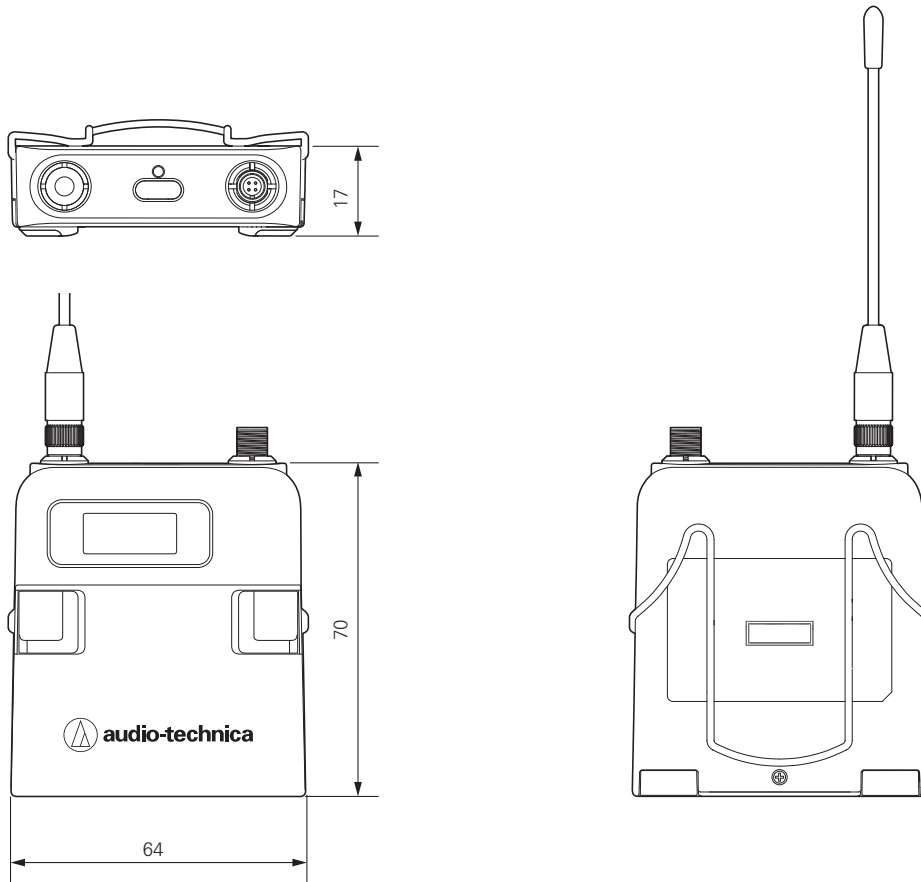

(Unit: mm)

### ATW-T5202

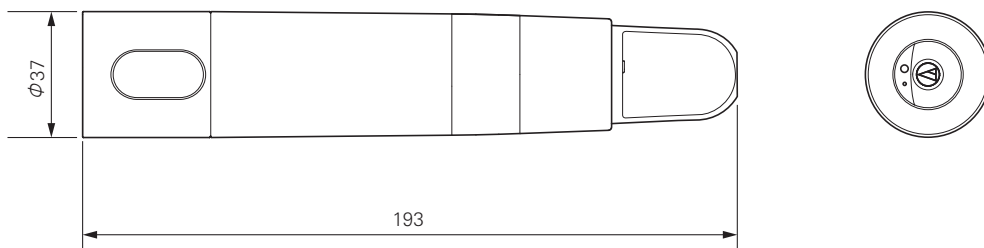

(Unit: mm)

# Specifications

## Overall system specifications

Operating frequencies*1	Frequency range	Number of frequencies
ATW-R5220/ATW-R5220DAN		
Band DG1:	470.125 to 699.875 MHz	9,191
Band DF1:	470.125 to 607.875 MHz, 657.100 to 662.900 MHz	5,511+233
ATW-T5201/ATW-T5202		
Band DE1:	470.125 to 590.000 MHz	4,796
Band EG1:	580.000 to 699.875 MHz	4,796
Band FE2:	580.000 to 607.875 MHz, 657.100 to 662.900 MHz	1,116+223
Minimum frequency step	25 kHz	
Modulation mode	FM	
Maximum deviation	ATW-T5201: ±40 kHz (THD:10%) ATW-T5202: ±40 kHz (THD:10%)	
Dynamic range	ATW-T5201 Mic input: 120 dB or higher (A-weighted), typical ATW-T5201 Inst input: 107 dB or higher (A-weighted), typical ATW-T5202: 116 dB or higher (A-weighted), typical	
Total harmonic distortion	1.0 % or less (at 1 kHz, ±17.5 kHz deviation)	
Operating range*2	100 m (328')	
Frequency response*3	ATW-T5201: 23 to 16,300 Hz ATW-T5202: 33 to 16,300 Hz	

\*1 Note that some frequency bands might not be available in country or region in which you live, or could come with a limited tuning bandwidth/transmitting power due to local regulations.

\*2 Open range environment with no interfering signals.

\*3 Depending on attached microphone element.

## ATW-R5220/ATW-R5220DAN

Receiving system	True diversity
Image rejection	80 dB nominal
RF sensitivity	18 dBuV at 60 dBA S/N ratio (50 ohms termination)
Maximum output level	XLR, Balanced, +18 dBV
Headphone output connector	6.3 mm (1/4") TRS Stereo
Headphone output power	180 mW, typical
Antenna input	BNC-type, 50 ohms
Antenna power	12 V DC, 150 mA (combined)
Power supply	100 to 240 V AC (50/60 Hz)
Operating temperature range	-5 °C to +45 °C (23 °F to 113 °F)
Dimensions	482.0 mm (18.98") x 361.0 mm (14.21") x 43.0 (1.69") mm (W x D x H)
Weight (without accessories)	Approx. 4.8 kg (169.3 oz)
Included accessories	Flexible UHF antenna x 2, Power cable, leg x 4

# Specifications

## ATW-T5201

RF output power <sup>*1</sup>	High: 50 mW, Mid: 10 mW, Low: 2 mW (switchable), at 50 ohms	
Spurious emissions	Following federal and national regulations	
Input connection	Four pin locking connector	
	Pin 1: GND	Pin 2: INST INPUT
	Pin 3: MIC INPUT	Pin 4: DC BIAS +10 V
		
High-pass (low-freq. roll-off)	80 Hz, 12 dB/octave	
Batteries	Two 1.5V AA, not included	
Operating temperature range	-5 °C to +45 °C (23 ° F to 113 °F)	
Battery life	High: 7 hours <sup>*2</sup> , Mid: 9 hours <sup>*2</sup> , Low: 10.5 hours <sup>*2</sup> (alkaline)	
Dimensions	64 mm (2.52") x 70 mm (2.76") x 17 mm (0.67") (W x D x H)	
Weight (without batteries)	Approx. 92 g (3.2 oz)	
Included accessories	Protective carrying case (AT-BG3)	

\*1 May differ depending on the country or region in which you live.

\*2 Depending on battery type, usage and environmental conditions.

## ATW-T5202

RF output power <sup>*1</sup>	High: 50 mW, Mid: 10 mW, Low: 2 mW (switchable), at 50 ohms	
Spurious emissions	Following federal and national regulations	
Microphone capsule	Interchangeable industry standard thread	
High-pass (low-freq. roll-off)	80 Hz, 6dB/octave	
Batteries	Two 1.5V AA, not included	
Operating temperature range	-5 °C to +40 °C (23 ° F to 104 °F)	
Battery life	High: 6.5 hours <sup>*2</sup> , Mid: 8 hours <sup>*2</sup> , Low: 9.5 hours <sup>*2</sup> (alkaline)	
Dimensions	ATW-T5202 (without capsule): 193 mm (7.60") long, 37 mm (1.46") maximum diameter ATW-T5202/C510: 265 mm (10.43") long, 54 mm (2.13") maximum diameter ATW-T5202/C710: 271 mm (10.67") long, 50 mm (1.97") maximum diameter	
Weight (without batteries)	ATW-T3202 (without capsule): 200 g (7.1 oz) ATW-T5202/C510: 330 g (11.6 oz) ATW-T5202/C710: 314 g (11.1 oz)	
Included accessories	AT8456a Quiet-Flex™ stand clamp (5/8"-27 male to 3/8"-16 female threaded screw adapter), Protective carrying case (AT-BG3)	

\*1 May differ depending on the country or region in which you live.

\*2 Depending on battery type, usage and environmental conditions.

For product improvement, the product is subject to modification without notice.

**Audio-Technica Corporation**

2-46-1 Nishi-naruse, Machida, Tokyo 194-8666, Japan

[www.audio-technica.com](http://www.audio-technica.com)

©2018 Audio-Technica Corporation

Global Support Contact: [www.at-globalsupport.com](http://www.at-globalsupport.com)

232417000-02-01 ver.1 2018.09.15