

# User Manual

## UHF SYNTHESIZED WIRELESS TRANSMITTER

# ATW-T6001 S

Thank you for purchasing this product.

Before using the product, take time to read this user manual thoroughly to ensure that you will use the product correctly.

Also keep this user manual handy, along with the warranty, so that they are always available for reference.

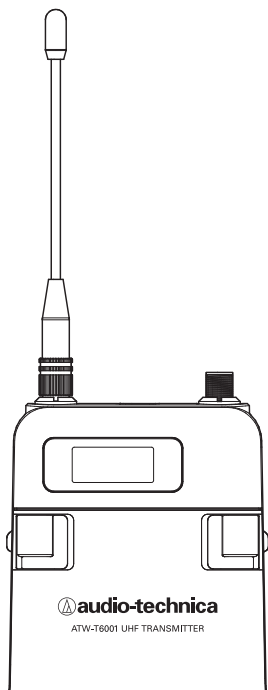

# Contents

Features	2
Important information	3
Notes on use	4
Using multiple wireless systems	4
Part names and functions	5
Inserting batteries	6
Display	7
Settings	8
Menu screen	8
Transmission frequency setting	9
NAME setting	9
Correcting characters	10
RF power setting	10
Gain setting	10
Mute lock setting	10
Key lock setting	11
Lock code setting	11
Battery setting	11
Using the mute function	12
Using the key lock function	12
Setting up the key lock function	12
Cancelling the key lock function	12
IR sync	13
Attaching the product to user's body	13
Troubleshooting	13
Specifications	14

# Features

- Uses advanced IMD suppression techniques to allow 31 simultaneous channels within a 4 MHz tuning bandwidth
- Comander circuitry provides greater dynamic range and lower noise
- Easy transmitter setup via IR sync
- Audio input adjustable from 0 to 20 dB of gain (2 dB steps)
- Compact transmitter design with rugged, ergonomic metal body
- A highly reliable, miniature microphone connector
- Compatible with a variety of headworn and lavalier microphones
- Clear, easy-to-read display
- Controls inside battery compartment to prevent accidental activation
- Lever push switch for easy menu navigation
- Flexible 1/4 wavelength whip antenna with broad operating range
- Battery fuel gauge selectable for alkaline or nickel-metal hydride type batteries

# Important information

**Warning:**

To prevent fire or shock hazard, do not expose this apparatus to rain or moisture.

**Caution:**

Do not expose this apparatus to drips or splashes.

To avoid electric shock, do not open the cabinet.

Refer servicing to qualified personnel only.

Do not expose this apparatus to excessive heat such as sunshine, fire or the like.

Do not subject this apparatus to strong impact.

**FCC Notice****Warning:**

Changes or modifications not expressly approved in writing by Audio-Technica may void the user's authority to operate this equipment.

This transmitter must not be co-located or operated in conjunction with any other antenna or transmitter used in other systems.

No user-serviceable parts inside. The circuits inside the transmitter have been precisely adjusted for optimum performance and compliance with federal regulations. Do not attempt to open the transmitter. To do so will void the warranty, and may cause improper operation.

**Batteries caution**

Keep batteries out of the reach of children.

Observe correct polarity as marked.

Do not expose batteries to excessive heat such as sunshine, fire or the like.

Always consider environmental issues and follow local regulations when disposing of batteries.

Remove depleted battery immediately.

Danger of explosion if battery is incorrectly replaced. Replace only with the same or equivalent type.

Do not use a new battery and an old one at the same time.

Do not use different battery types or models together.

Do not use a leaking battery. If battery leakage occurs, avoid contact with skin.

If contact occurs, immediately wash skin thoroughly with soap and water.

If battery leakage comes into contact with your eyes, immediately flush eyes with water and seek medical care.

## Notes on use

- Be sure to read the user manual for any microphone or cable that you attach to the product.
- If you use the product close to an electronic or communications device (such as a mobile phone), the product may produce unwanted noise. If this occurs, move the product away from the device.
- When setting up and using the product, make sure there are no obstacles between it and the receiver that might block the signal.
- If you use the product near a TV or radio antenna, you may hear unwanted noise in the television or radio. If this occurs, keep the product away from the television or radio.
- To prevent the batteries from wearing out, turn the product off when not in use.
- Over time, discoloration may occur due to ultraviolet rays (especially direct sunlight) and friction.
- Any customization of the product is prohibited by law. Also, disassembly of the product may result in electrical shock, equipment damage or fire. Never disassemble the product.

## Using multiple wireless systems

- When using multiple units simultaneously, maintain approximately 1 meter or more between individual transmitters and approximately 10 meters or more between transmitters and receivers' antennas.
- When using multiple units, power on transmitters one by one, making sure there is no unwanted noise.

# Part names and functions

**Transmission antenna**

**Display**

Shows the current status.

\* If no buttons are pressed for a period of 20 seconds, the display will turn off.

**SYNC button**

Use for IR sync with a receiver.

**BACK button**

Returns to the previous operation.

**Lever push switch**

Used for selecting various settings.

**UP (▶)**

Turn to the right to change a selection.

**DOWN (◀)**

Turn to the left to change a selection.

**SET (●)**

Press to confirm a selection.

\* For details on how to operate, see "Settings."

**Input connector**

Connect a microphone (Sold separately).

**Power switch**

Turns the power on/off.

Front

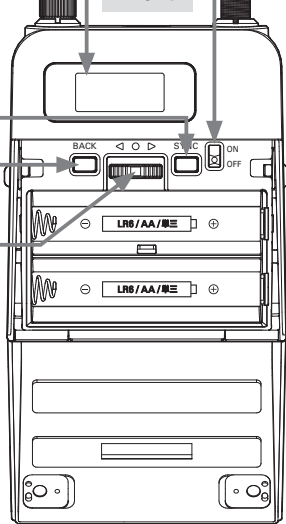

**IR sync window**

Use when syncing the product to the receiver.

Rear

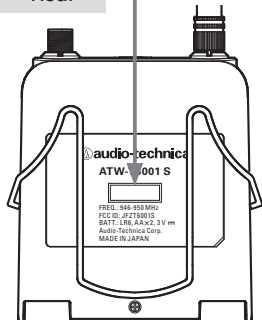

**Power indicator**

Lights in green when the power is on. Lights in red when battery power is low.

Top

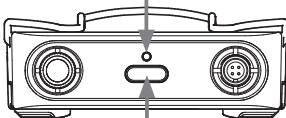

**Recall/Mute button**

Press to turn the screen back on if it shuts off.

Press and hold to switch audio mute on and off.

## Inserting batteries

1. Slide the battery cover latches inward as shown by the arrows.

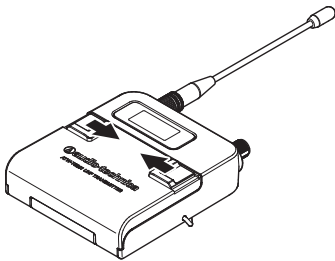

2. With the latches pressed in, slide the cover down as shown by the arrow.

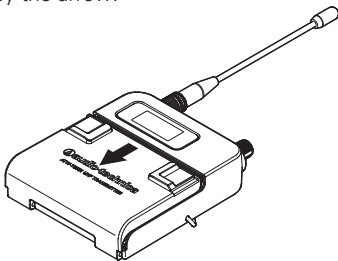

3. Open the battery cover as shown in the diagram.

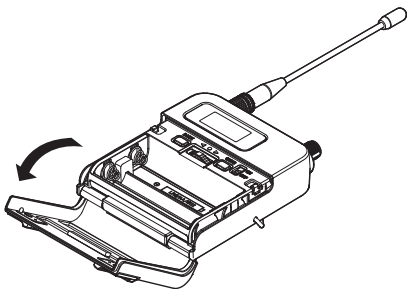

4. Insert the batteries according to the plus (+) and minus (-) marks found inside the battery compartment.

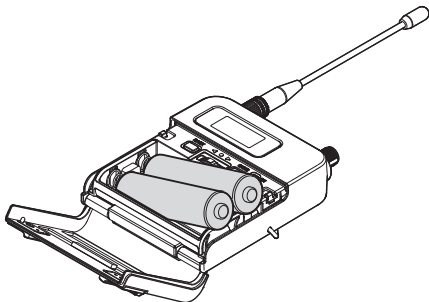

# Display

The main screen is displayed when the power is switched on.

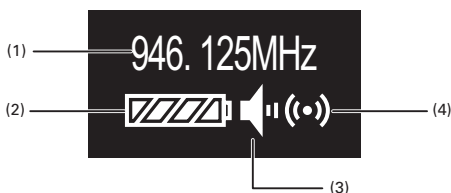

## (1) Frequency/NAME

Press the UP/DOWN to switch screens.

\* Frequency displays as the default setting.

## (2) Battery power indicator

Shows how much battery power is remaining.

 : 75 % or more battery power remaining.

 : 50 to 75 % battery power remaining.

 : 25 to 50 % battery power remaining.

 : 25 % or less battery power remaining.

 : Charge/replace the batteries.

\* Use as a general guide for determining how much battery power has been consumed.

\* If there is no remaining battery power, replace the batteries. If rechargeable batteries are in use, charge them.

## (3) Microphone gain screen

 : 0 to 6 dB

 : 8 to 12 dB

 : 14 to 20 dB

 : Muted

## (4) RF power output screen

 : RF Power High (50 mW)

 : RF Power Mid (10 mW)

 : RF Power Low (2 mW)

# Settings

## ■ Menu screen

Press SET (●) on the lever push switch for menu screen mode. Moving UP (▶) / DOWN (◀) takes you to the various setting screens in the order shown below.

\* If there is no switch operation within 10 seconds, the display returns to the main screen.

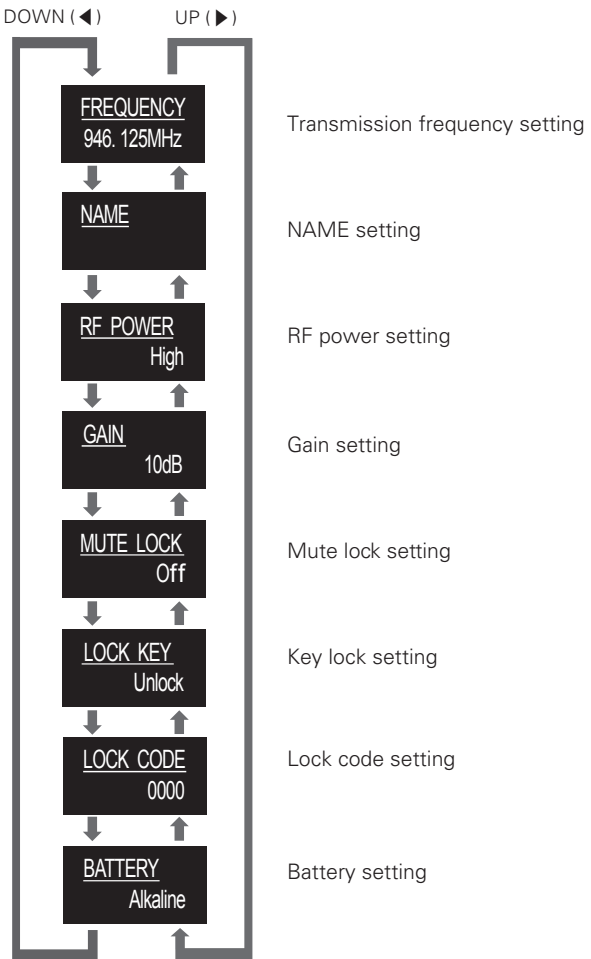



## Transmission frequency setting

FREQUENCY  
947.000MHz



FREQUENCY  
947.000MHz



FREQUENCY  
948.000MHz



FREQUENCY  
948.000MHz



FREQUENCY  
948.125MHz

From the menu screen, use UP/DOWN to select "FREQUENCY," and then press SET.

A line is displayed under the first three digits.

Use UP/DOWN to select the frequency.

Press SET.

A line is displayed under the last three digits.

Use UP/DOWN to select the frequency.

Press SET.

"STORED" is displayed, and the transmission frequency setting is complete.

## NAME setting

The maximum number of characters that can be entered is 10.

The following types of characters can be entered.

- Alphabetic (52 letters/upper and lower case)
- Period
- Numeric
- Plus
- Space
- Minus

NAME



NAME  
v



NAME  
vocal\_



NAME  
vocal \_

From the menu screen, use UP/DOWN to select "NAME," and then press SET.

Use UP/DOWN to select characters.

When the desired character is displayed, press SET. This confirms the selection and moves the cursor to the right.

Repeat the operation until all characters are entered.

An entry of 10 characters is required.

If less than 10 characters is desired, set the entry for SPACE and press SET until the cursor moves to the 10th character position.

At the 10th character position, press SET.

Once pressed, "STORED" is displayed and NAME setting is complete.

## ■ Correcting characters

---

To correct a character after it is entered, select "BS" with UP/DOWN.

When SET is pressed, the last entered character is deleted and the cursor moves one position to the left.

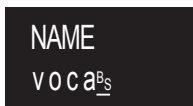

## ■ RF power setting

---



From the menu screen, use UP/DOWN to select "RF POWER," and then press SET.

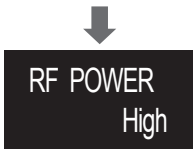

Use UP/DOWN to select the RF power.

Use UP/DOWN to switch between "High," "Mid" and "Low."

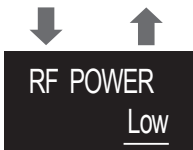

Press SET.

"STORED" is displayed, and the RF power setting is complete.

## ■ Gain setting

---



\*Initial setting is 10 dB.

From the menu screen, use UP/DOWN to select "GAIN," and then press SET.



Use UP to increase gain in 2 dB steps.

Use DOWN to decrease gain in 2 dB steps.



After selecting the gain, press SET.

"STORED" is displayed, and the gain setting is complete.

## ■ Mute lock setting

---



Display the mute lock status.

Off: Mute function enabled

On: Mute function disabled



From the menu screen, use UP/DOWN to select "MUTE LOCK," and then press SET.



Use UP/DOWN to select the mute lock setting, then press SET.

"STORED" is displayed, and the mute lock setting is complete.

## ■ Key lock setting

---



Display the key lock status.

Unlock: Keys unlocked

Lock: Keys locked



From the menu screen, use UP/DOWN to select "LOCK KEY," and then press SET.



Use UP/DOWN to select the key lock setting, then press SET.

"STORED" is displayed, and the key lock setting is complete.

## ■ Lock code setting

---

The lock code is a 4-digit code (from 0000 to 9999) for unlocking the keys. If the key lock function is activated, the lock code is required to enter the menu from the main screen.



From the menu screen, use UP/DOWN to select "LOCK CODE," and then press SET.



Press UP/DOWN to select a number from 0 to 9.

Once the desired number is displayed, press SET to confirm the selection.



Repeat the operation until four digits have been entered. Once the fourth digit has been entered, press SET.

Once pressed, "STORED" is displayed and the lock code setting is complete.

## ■ Battery setting

---



Set the type of batteries used.

From the menu screen, use UP/DOWN to select "BATTERY," and then press SET.



Alkaline      Select for alkaline batteries

Ni-MH        Select for nickel-metal hydride batteries



If the appropriate setting is not made for the batteries used, the battery power indicator will not display the correct information. Always set the type of battery according to the batteries used.

After selecting the battery type, press SET.

"STORED" is displayed, and the battery setting is complete.

## Using the mute function

The mute function allows you to manually mute your microphone when, for example, there is a gap in the middle of a speech, or you want to change the settings and transmitting audio would be a problem.



Unmuted

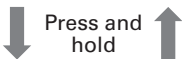

Muted

When you press and hold the Recall/Mute button, "MUTE ON" is displayed on the screen and your microphone is muted.

When you press and hold the Recall/Mute button again, "MUTE OFF" is displayed on the screen and your microphone is unmuted.

This function can be disabled using "MUTE LOCK" in the menu. For details, see "Mute lock setting".

## Using the key lock function

The key lock function prevents entry into the menu screen to avoid any unwanted changes to the product's settings.

When the key lock function is set to "Lock," the entry of a lock code is required in order to proceed to the menu screen.

### Setting up the key lock function

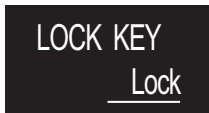

1. Set up a lock code.

\* Do not forget the 4-digit code that you set up.

2. Set the key lock function to "Lock."

\* The key lock function is activated once you press BACK and return to the main screen.

### Cancelling the key lock function

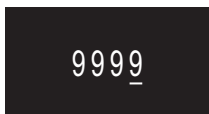

1. If the key lock function is activated, pressing SET when the main screen is on displays the lock code entry screen.

\* If there is no operation within 10 seconds or if BACK is pressed, the display returns to the main screen.

2. Enter the 4-digit lock code which was set up earlier. Use UP/DOWN to select a desired number and press SET. Repeat the operation until all four numerals are entered.

3. Once all four numerals are entered, press SET. If the correct lock code has been entered, the menu screen is displayed.

4. The key lock function can be disabled by going to the menu screen and setting the function to "Unlock."

## IR sync

The product is equipped with an IR sync function. It allows you to easily configure the product settings from the receiver.

See the receiver's user manual for instructions on how to use IR sync.

## Attaching the product to user's body

The product is equipped with a clip. Use that to attach the product to a belt, pocket or other piece of clothing that will hold it.

You can reverse the direction that the input connector faces by attaching the clip in the opposite direction.

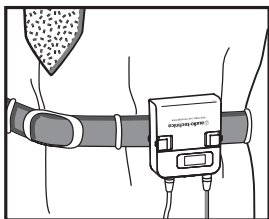

Pull both sides of the clip firmly to the outside to remove the clip from the product.

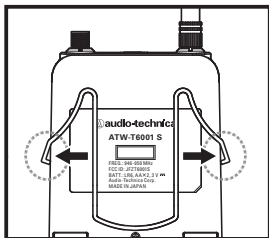

## Troubleshooting

"LOW BATT" is displayed and the unit does not respond to operation.

→ Are the batteries depleted?

There is no voice output. The voice output level is low.

- Are the frequency settings for this product and the receiver correct?
- Has the appropriate input level for this product been set?
- Is the microphone properly connected?
- Is the volume for an instrument that is connected to the receiver completely turned down?

Sound is distorted.

→ Is the product input level set too high?

There is unwanted noise.

- Are fluorescent lamps, electric appliances, and other sources of noise kept away from the product or receiver?
- Is the receiver set up near a source of noise? Noise may also be generated if power is being taken from the same outlet as a device that produces a lot of noise.

## Specifications

Operating frequency: 946.125 MHz to 949.875 MHz (31 channels)

Frequency step: 125 kHz

Spurious emissions: Following federal and national regulations

RF power output: 50 mW/ 10 mW/ 2 mW

Normal deviation:  $\pm 5$  kHz

Maximum deviation:  $\pm 16.25$  kHz

Frequency response: 70 to 15,000 Hz

Batteries: Two 1.5 V AA alkaline

Operating temperature range: 5 °C to 45 °C (41 °F to 113 °F)

Battery life: Approx. 6 hours (using two alkaline batteries)

Current consumption: 230 mA or less (at DC 3 V)

External dimensions: 62 (2.44") x 70 (2.76") x 17 (0.67") mm  
(excluding protrusions)

Weight: Approx. 90 g (3.2 oz) (excluding batteries)

(Specifications are subject to change without prior notice.)

# Memo

A series of horizontal dotted lines for writing a memo.

