

AT-DMM828

Digital Matrix Mixer

Installation and Operation



AT-DMM828

Digital Matrix Mixer

Installation and Operation

Warning:

To prevent fire or shock hazard, do not expose this apparatus to rain or moisture.

Caution:

To avoid electric shock, do not open the cabinet.

Refer servicing to qualified personnel only.

To prevent fire, do not place any naked flame sources (such as lighted candles) on this apparatus.

To prevent fire, do not cover the ventilation of this apparatus with newspapers, table-clothes, curtains, etc.

Do not expose this apparatus to drips or splashes.

Do not place any objects filled with liquids, such as vases, on this apparatus.

Do not install this apparatus in a confined space such as a bookcase or similar unit.

To install this apparatus only in the place where ventilation is good.

This apparatus should be located close enough to the AC outlet so that you can easily grasp the power cord plug at any time.

In case of emergency, disconnect the power cord plug of this apparatus quickly.

This apparatus with Class I construction shall be connected to the AC outlet with a protective grounding connection.

This apparatus is not disconnected from the mains as long as it is connected to the AC outlet, even if the unit itself has been turned off.

Important Safety Instructions

- 1) Read these instructions.
- 2) Keep these instructions.
- 3) Heed all warnings.
- 4) Follow all instructions.
- 5) Do not use this apparatus near water.
- 6) Clean only with dry cloth.
- 7) Do not block any ventilation openings. Install in accordance with the manufacturer's instructions.
- 8) Do not install near any heat sources such as radiators, heat registers, stoves, or other apparatus (including amplifiers) that produce heat.
- 9) Do not defeat the safety purpose of the polarized or grounding-type plug.
A polarized plug has two blades with one wider than the other.
A grounding type plug has two blades and a third grounding prong.
The wide blade or the third prong are provided for your safety.
If the provided plug does not fit into your outlet, consult an electrician for replacement of the obsolete outlet.
- 10) Protect the power cord from being walked on or pinched particularly at plugs, convenience receptacles, and the point where they exit from the apparatus.
- 11) Only use attachments/accessories specified by the manufacturer.
- 12) Use only with the cart, stand, tripod, bracket, or table specified by the manufacturer, or sold with the apparatus.
When a cart is used, use caution when moving the cart/apparatus combination to avoid injury from tip-over.
- 13) Unplug this apparatus during lightning storms or when unused for long periods of time.
- 14) Refer all servicing to qualified service personnel. Servicing is required when the apparatus has been damaged in any way, such as power-supply cord or plug is damaged, liquid has been spilled or objects have fallen into the apparatus, the apparatus has been exposed to rain or moisture, does not operate normally, or has been dropped.



CAUTION RISK OF ELECTRIC SHOCK DO NOT OPEN	AVIS RISQUE DE CHOC ÉLECTRIQUE NE PAS OUVRIR
	To prevent electric shock, do not remove the cover. There are no user-serviceable parts inside. Internal adjustments are for qualified professionals only. Refer all servicing to qualified service personnel.
	Pour prévenir un choc électrique, ne pas ouvrir le couvercle. Il n'y a aucune pièce de rechange à l'intérieur. Tout ajustement interne doit être fait par une personne qualifiée seulement. Référez tout réparation au personnel qualifié.

Caution for FCC

You are cautioned that any changes or modifications not expressly approved in this manual could void your authority to operate this equipment.

Warning for FCC

This device complies with Part 15 of the FCC Rules. Operation is subject to the following two conditions: (1) This device may not cause harmful interference, and (2) this device must accept any interference received, including interference that may cause undesired operation.

Note: This equipment has been tested and found to comply with the limits for a Class B digital device, pursuant to part 15 of the FCC Rules. These limits are designed to provide reasonable protection against harmful interference in a residential installation. This equipment generates, uses and can radiate radio frequency energy and, if not installed and used in accordance with the instructions, may cause harmful interference to radio communications. However, there is no guarantee that interference will not occur in a particular installation. If this equipment does cause harmful interference to radio or television reception, which can be determined by turning the equipment off and on, the user is encouraged to try to correct the interference by one or more of the following measures:

- Reorient or relocate the receiving antenna.
- Increase the separation between the equipment and receiver.
- Connect the equipment into an outlet on a circuit different from that to which the receiver is connected.
- Consult the dealer or an experienced radio/TV technician for help.

IC statement

CAN ICES-3 (B)/NMB-3(B)

About Power Cord

This model does not include AC power cord.

Therefore, you have to purchase it at your local store. You can confirm it at "Power Cord List".

Power Cord List

Power supply cord for 120 Vac power supply in U.S.A, Canada :

Approved by UL, CSA

Detachable, rated minimum 125 V, minimum 10 A, marked VW-1. Includes 3 x 18 AWG, Type SVT flexible cord. Minimum length 1.5 m.

One end terminates in a parallel blade, molded-on attachment plug rated 125 V, 10 A with a polarized NEMA 5-15P blade configuration.

Other end terminates in an appliance coupler.

Introduction

Please Note!

This manual assumes use of microphone-level inputs and line-level output for most typical SmartMixer applications. However, all inputs may be individually switched via the included AT-DMM828 Control Software to achieve any combination of mic-level and line-level inputs.

Signal flow can be changed via the included AT-DMM828 Control Software. Refer to Software Manual for more information.

About the AT-DMM828

AT-DMM828 is a microprocessor-controlled, programmable, automatic-switching eight-channel matrix mixer. It can be used with low-impedance either dynamic or condenser microphones (including wireless microphone systems), as well as line-level sources.

AT-DMM828 is designed to improve audio quality in broadcast, sound-reinforcement and recording applications. One way it achieves this is by keeping the number of open microphones to minimum, thus reducing background noise, feedback and other distractions, while providing instant, completely transparent switching between channels.

Each of the eight balanced inputs provides switchable 48Volt phantom power; attenuation is also selectable on each input to allow use with line-level signals. The mixer's outputs are balanced and non-inverting. All audio connections terminate in block screw connectors.

Up to 16 units of AT-DMM828 (a total of 128 channels inputs) can be daisy-chained via CAT6 cable, which carries control bus, audio, and configuration data between mixers.

Multiple mixers linked in this way will operate as if they are a single mixer. Therefore, microphones activated on any mixer will cause the appropriate switching functions to occur. The link connectors are not compatible with LAN.

Each AT-DMM828 includes two separate external control system interfaces:

Individual channel contact closures (via DB25 connector) and PC control (via RS232 connector or USB). The RS232 connector can also be used to connect an external control system (e.g. Crestron® or AMX®) using "open disclosure communication protocol" to control the mixer.

AT-DMM828 Features

- Eight balanced inputs allow to be used with either mic-level or line-level signal.
Each input provides:
 - 48V phantom power (individually selectable)
 - Individual gain and sound volume controls
 - Gate attenuation adjustable (0 dB to full mute in steps of 1 dB)
 - Gate hold time adjustable (0.1 sec to 6.0 sec in steps of 0.1 sec)
 - Mic on threshold level adjustable (Auto/Manual)
- DSP algorithm
 - Signal level meter (Peak/RMS)
 - Signal generator (Sine wave/Pink noise/White noise) *input channel only
 - Parametric EQ (3 band/4 band)
 - Filter (Low pass/High pass/Low shelving/High shelving/Notch/All pass)
 - Limiter
 - Delay *output channel only
 - 8×8 full matrix-mixing (can be extended to 128×8 matrix-mixing)
- Selectable NOMA (Number of Open Microphones Attenuated)
 - Automatic gain adjustment as each microphone is activated
- Selectable manual mode overrides automatic functions
- Linking capability for up to 16 units (up to 128 inputs)
- Selectable external connector's pin assignment
 - Gate status output (using for the Camera moving)
 - Gate On/Off (using for input gate control by tactile switch)
 - Mute On/Off /Toggle (using for channel level control by tactile switch)
 - Volume Up/Down (using for channel level control by tactile switch)
 - VCA function (using for channel level control by external potentiometer)
- Compatible with Crestron® or AMX® systems
- All settings can be adjusted or modified through AT-DMM828 Control Software
- Mounts in a single U 19" rack space (EIA Standard)

AT-DMM828 Front Panel

Figure 1 – AT-DMM828 Front Panel Layout

- | | |
|---|---|
| <p>1. USB connector
To connect PC using its own software to configure internal settings</p> <p>2. Link status indicator
LED lights green when linked normally and red when the error occurred</p> | <p>3. Power "ON" indicator</p> <p>4. Power Switch</p> <p>5. Fan will automatically turn on when internal temperature exceeds 60°C (140°F).</p> |
|---|---|



Figure 1

AT-DMM828 Rear Panel

Figure 2 – AT-DMM828 Rear Panel Layout

- | | |
|---|--|
| <p>6. AC Inlet
100-240V AC, 50/60Hz, 25W</p> <p>7. External Control Connector (25-pin D-Sub Female)
Provides external connection points to control AT-DMM828 using contact closures</p> <p>8. Serial Data Connector (9-pin D-Sub Female)
RS232 data port allows PC to connect or as an interface port for Central Control System like Crestron®, AMX® or other brands' control systems using open communication protocols to configure internal mixer settings</p> | <p>9. Link In/Link Out connector (RJ-45)
Provides cascade connections of multiple mixers when more than eight microphones are used
Use CAT6 cable. Maximum length is 0.5m.

NOTE: Use high quality CAT6 cable when linking mixers. Signal degradation will occur with low quality cable or connections resulting in communication errors between mixers.</p> <p>10. Output Connectors (3-pin block screw connector)
Pin-1: Hot; Pin-2: Cold; Pin-3: Ground
Provides balanced mixing output</p> <p>11. Input Connectors (3-pin block screw connector)
Pin-1: Hot; Pin-2: Cold; Pin-3: Ground
Provides balanced input</p> |
|---|--|

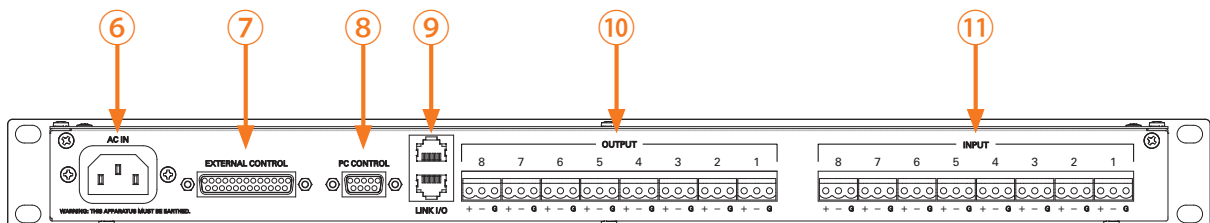

Figure 2

Installation and Setup

Out of the box, the AT-DMM828 comes configured for most common applications. Here are some basic setup tips to help quickly setup and running.

Installing the software

Computer requirements

To run the software, the following minimum computer hardware and software configuration are required.

Hardware:

- Pentium processor running at 1.6 GHz or better
- 4 GB hard disk space recommended for application
- 1 GB RAM
- 9-pin RS232 Serial Data Port (Com Port) or USB interface
- CD ROM Drive
- Computer display capable of supporting at least 1024×768 pixel resolution

Operating System / Software:

- Microsoft® Windows® XP SP3 and up including the following versions:
 - Windows Vista 32 bit version
 - Windows Vista 64 bit version
 - Windows 7 32 bit version
 - Windows 7 64 bit version
 - Windows 8 32 bit version
 - Windows 8 64 bit version

Note: This software will not run on LINUX® or Mac OS based system.

Note: This software requires Microsoft .NET Framework 4 Client Profile. If the computer does not have .NET Framework 4 Client Profile installed, the installation process will ask to install it during setup. After installation process finishes, it will ask to restart the computer.

Installing the software

Note: It must have administrator rights for the computer to install the software.

1. Close all running applications
2. Insert the AT-DMM828 Software CR ROM into the computer's CD ROM drive
Use "Browse" to locate the setup file on the CD ROM
3. When "Setup" is executed, the Setup welcome dialog box appears
4. Click OK to begin setup Wizard

Connecting the AT-DMM828 to the computer

Connect a standard 9-pin RS232 type data cable (or USB cable) between the computer and the RS232 port on the back panel (the USB port on the front panel) of the AT-DMM828. If multiple AT-DMM828s are linked together, connect the data cable to the master unit in the linked chain.

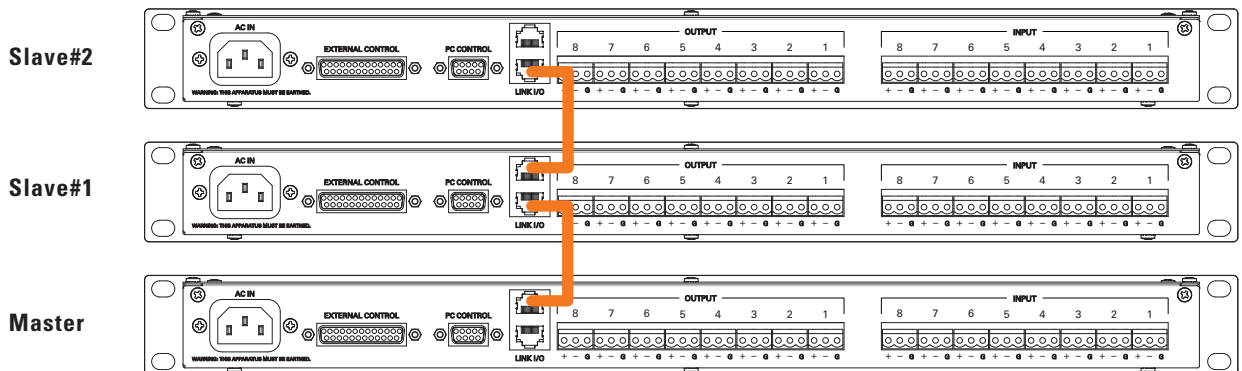

Set the master unit to the bottom and connect to upper slave units.

Control Software Functions Explanation

Main Window

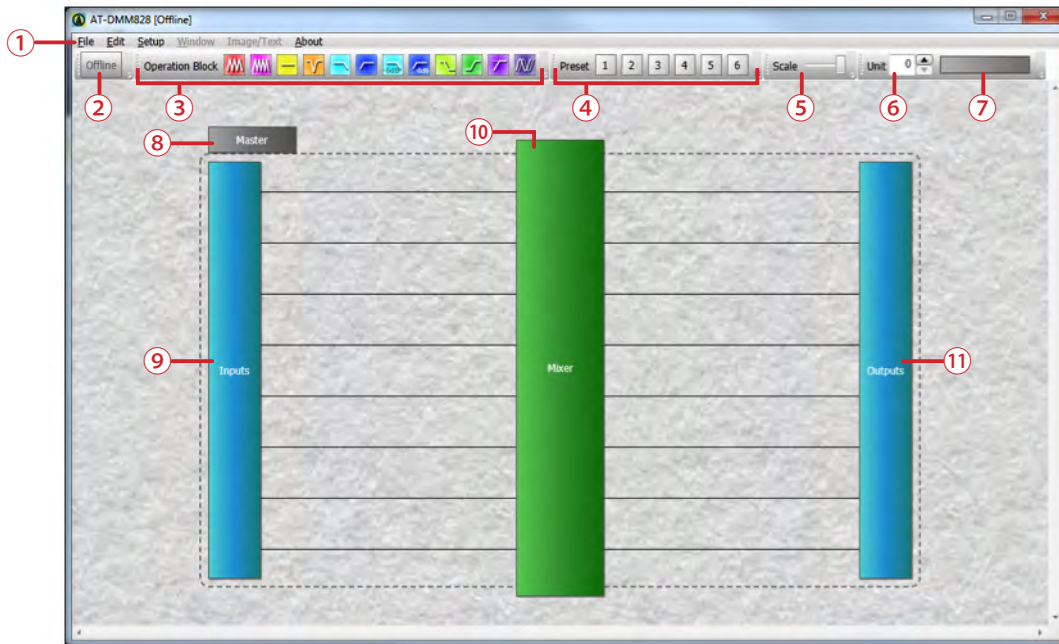

1. Menu Bar

- File:** To save and to open files and it can also print the window
- Edit:** To copy and to paste operation blocks and it can also insert images and texts
- Setup:** To set window parameters settings window, the software settings window and communication settings window and it can restore mixer to factory default settings
- Window:** To select the open windows
- Image/Text:** To select inserted images and texts
- About:** To check software version and firmware version

2. Online/Offline Indicator: Indicator will change to orange color when PC and AT-DMM828 are connected, and Communications Settings window can be displayed by double-click this indicator

3. Operations Block: To adjust the internal block of the mixer by dragging and dropping these blocks (Refer to "Customizing the DSP block" & Operations Blocks' Descriptions)

4. Preset: maximum of 10 presets' data can be saved in PC. Yellow icon indicates it has already got preset data



Right-click either yellow or gray icon to save current setting

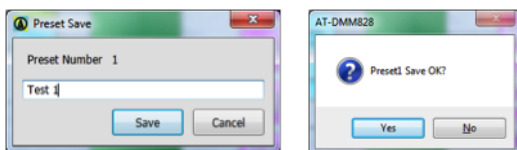

Left-click the yellow icon to load the preset data

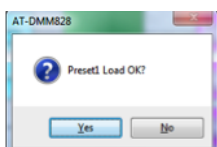

5. Scale: Can adjust the scale of the main block by sliding the button

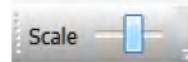

6. Unit: To select the unit to display its DSP usage

7. DSP Resource Monitor: To display each unit DSP processing usage

1. Orange color: Input block processing usage
2. Light Blue color: Output block processing usage

8. External Settings: Double-click this icon to display External Control Terminal Settings window

9. Input Channel Settings: Double-click this icon to display Input channel settings window

10. Matrix Mixer Settings: Double-click this icon to display Matrix mixer settings window

11. Output Channel Settings: Double-click this icon to display Output channel settings window

Parameter Settings

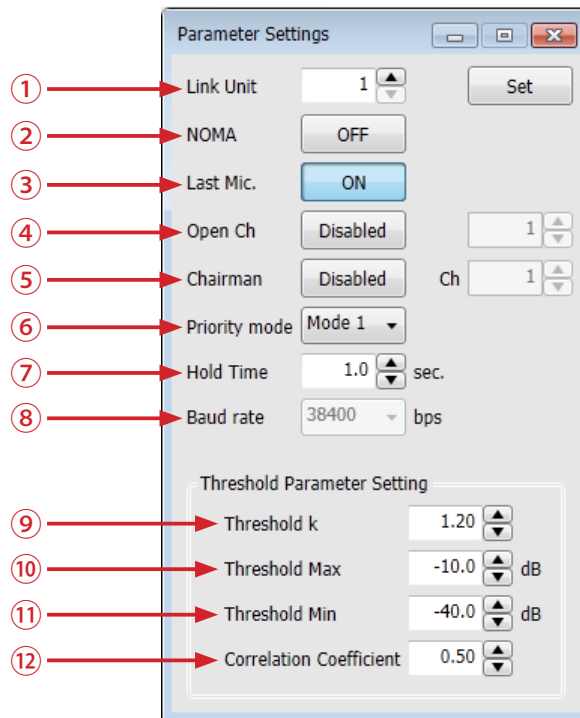

1. **Link Unit:** Select the number of the system unit; change the number and click the "Set" button
2. **NOMA:** Set number of Open Microphones Attenuated (NOMA) On/Off
3. **Last Mic:** Select the Last Mic On/Off.
 - In any of the modes of operation, the last microphone "ON" will remain "ON" when talking ceases, to provide continuous room ambience
4. **OpenCh:** Set the maximum number of channel openings from 1 to 16; select "Disable", the number of channel openings is not restricted
5. **Chairman:** When the channel set as the chairperson becomes open, other channels are closed compulsorily
 - The number means that Master's channel 1 is "1" and channel 2 is "2". Slave#1's channel 1 is "9" and channel 2 is "10"... Slave#15's channel 8 is "128"
6. **Priority mode:** This mixer has two priority modes

The maximum gate open number limits the number of open channels over the system

 - Mode 1: The channel to which the priority was set also receives restriction of the number of the maximum channels
 - Mode 2: The channel to which the priority was set does not receive restriction of the number of the maximum channels
7. **HoldTime:** Select the gate hold time 0.1 to 6.0 sec (0.1 sec stepping)
8. **Baudrate:** It is a baud rate of a mixer, and it can change the baud rate in the online mode. A preset value is reflected after a mixer reboots; 38400, 57600, & 115200 bps
9. **Threshold K:** Auto threshold sensitivity. A higher value will make it more difficult to trigger the gate open. Range is 1.00 to 3.00 (0.01 stepping)
10. **Threshold Max:** The maximum dB that will trigger a gate to open. Reducing the possibility of transient sounds false triggering the gate. Range is -80 to 0dB (0.1 stepping)

11. **Threshold Min:** The minimum dB that will trigger a gate to open. Reducing the possibility of gates closing and interrupting active dialogue. Range is -80 to 0dB (0.1 stepping)
12. **Correlation Coefficient:** This value adjust the calculations used to determine if multiple channels are receiving the same source. A higher value will make it more likely for multiple microphones to pass the same source. This value is factory set and in most cases should remain at the default level of 0.50. Range is 0.01 to 1.00 (0.01 stepping)

Suggestions for using multiple microphones: Proper adjustment of the Threshold K for background noise and other non-intended audio will ensure best operation of the auto-mixer.

Adjusting Threshold K: This level should be set to the ambient noise of the room (Computer fans, video projector fans, HVAC, etc.) so as not to trigger the gain reduction.

With two people speaking into two microphones adjust the Threshold K until the gain reduction activates and stays on during short pauses in speech. This value should be increased in high ambient noise applications.

Adjusting Threshold Maximum: This controls false triggers of the automatic gate regardless of the microphone channel gain setting. Setting this level too low can cause transient sounds such as coughs or table pounds to trigger a gate.

Adjusting Threshold Minimum: will help control false triggers of the automatic gate regardless of the microphone channel gain setting. Setting this level too high can cause the gate to cut off words.

NOMA or Number of Open Microphones Attenuator utilizes audio thresholds to manage a shared total gain. As more microphone channels are opened, the gain of each channel is attenuated to achieve the same total output level regardless of the amount of microphone gates open.

There are the limits of this automix method. When using more than 10 channels the NOMA setting may not be achievable in "Auto-Mode". Directions for using a manual mode and optimizing each channel individually can be found on (P.19).

Software Settings

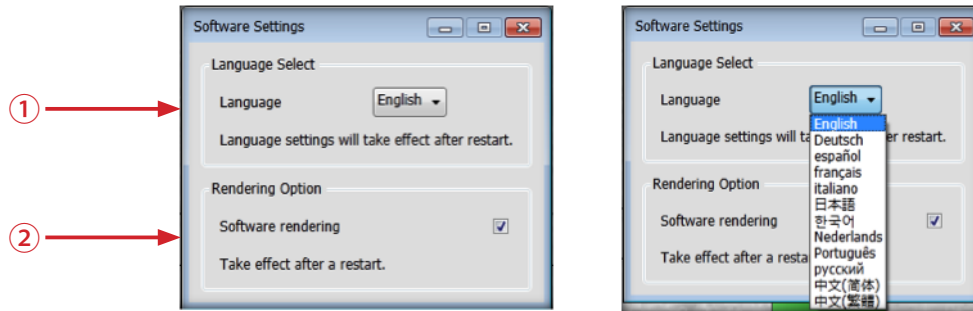

1. **Language:** Select the language that will display
 - a. Language available: English, German, Spanish, French, Italian, Japanese, Korean, Dutch, Portuguese, Russian, Traditional Chinese, Simplify Chinese
2. **Software rendering:** Number of Open Microphones Attenuated (NOMA) is set

Communications Settings

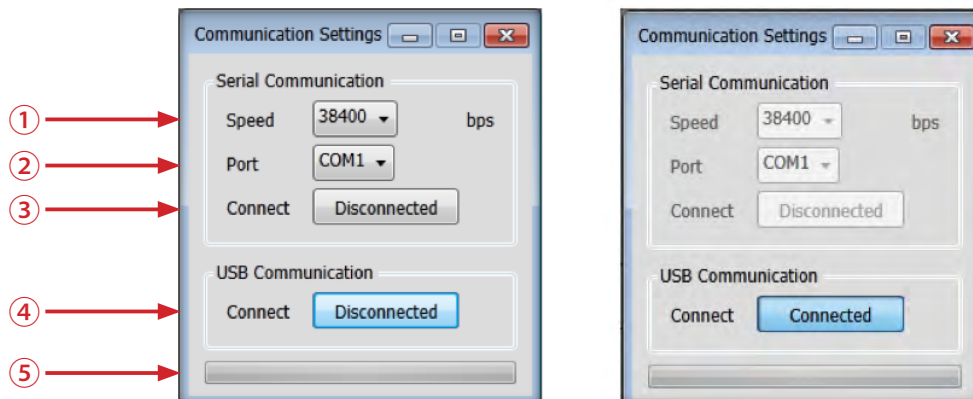

1. **Serial Communication Speed:** Adjustable range is 38400 to 115200 bps
*It is necessary to make it the same value as the baud rate of parameter setup
2. **Port:** The port where the mixer connect/disconnect to the PC
3. **Serial Connect button:** The mixer is connected or disconnected to the PC via serial port
4. **USB Connect button:** Select connect or disconnect to the PC using USB interface
5. **Progressive Bar:** The progress of connection will be displayed

RS232 Control Port

A rear panel RS232 port (9-Pin) is provided to allow for the connection of a computer running the AT-DMM828 Control Software application or external control system (Crestron® or AMX®) is using open disclosure communications protocol.

Customize the DSP block

Adjust the internal block of this mixer in offline mode

A block which you want to add is chosen from an operation block area and it dragging and dropping on the line of a channel.

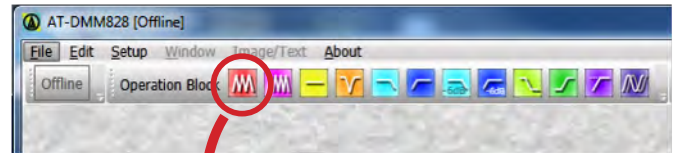

It can drop, if a line changes to pink.

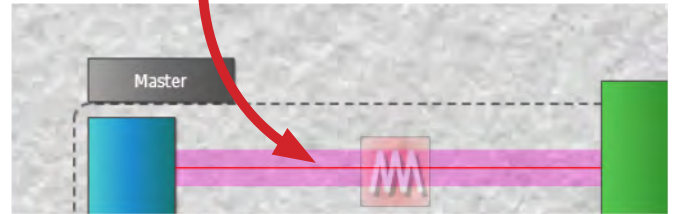

The number of the blocks which can be arranged to each channel has restriction.

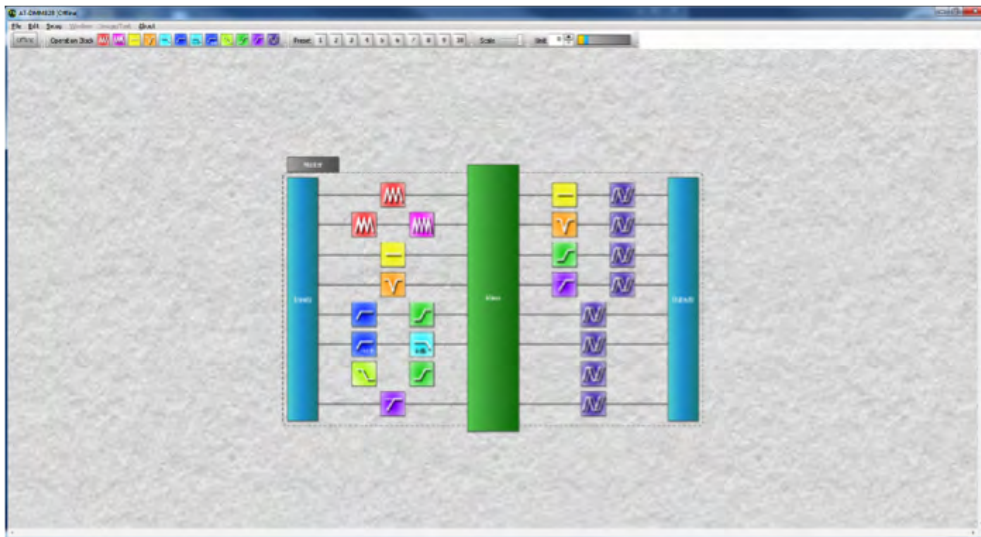

The delay block can arrange only to output side.

Operations Blocks' Descriptions

● 3 Band Equalizer Settings

Double-click "Equalizer" block,  3 Band EQ will display the following window

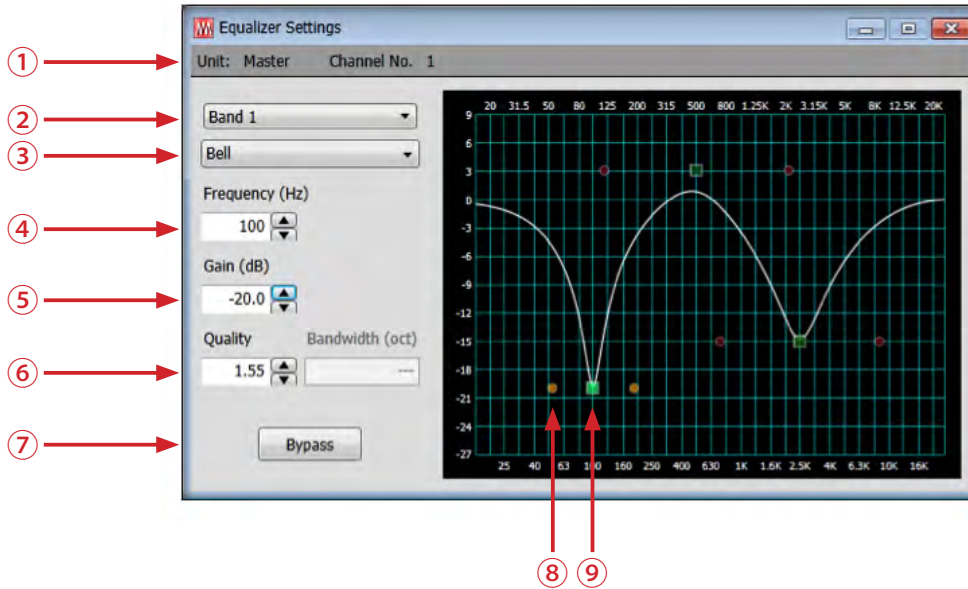

1. **Unit name and Channel No:** The unit name and channel number to which this block is set will be displayed
2. **Band:** Click and select the band to adjust;
 - 3 band EQ has Band 1 (100 Hz), Band 2 (500 Hz) and Band 3 (2500 Hz)
3. **Equalizer type:** Click and select the equalizer type;
 - Low Shelving
 - High Shelving
 - Notch
 - Bell (default)
4. **Frequency:** To select the center frequency (Hz) for the current band; range is from 20 Hz to 20 kHz (1 Hz stepping)
5. **Gain:** To adjust the amount of boost or cut applied at the center frequency for the current band from 9 to -27 dB (0.1 dB stepping); default at 0 dB
6. **Quality:** Q or Quality factor, selects the ratio of the center frequency divided by the bandwidth. Q reflects an inverse relationship to the bandwidth, and adjust from 0.01 to 50.00 (0.01 stepping); default at 0.50
7. **Bypass:** When selected, it will bypass this filter
8. **Quality dot:** Q factor dot
9. **Frequency square:** These settings may be adjusted by dragging the band controls shown inside the graph

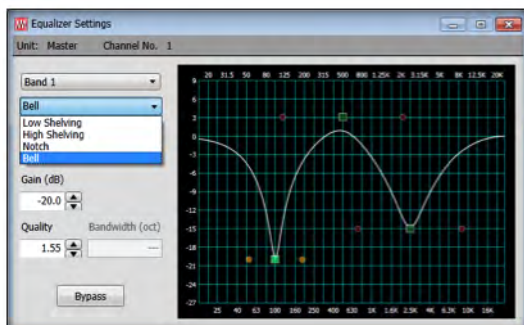
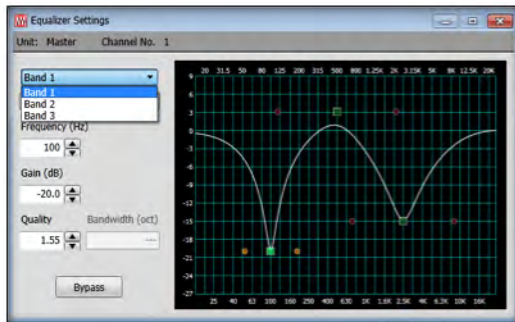

4 Band Equalizer Settings

Double-click "Equalizer" block,



4 Band EQ will display the following window

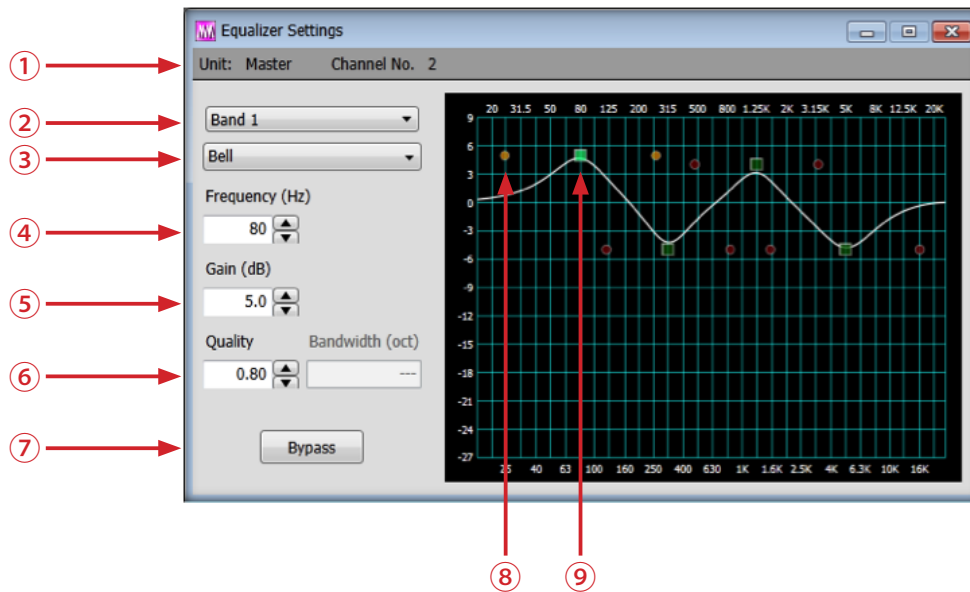

- Unit name and Channel No:** The unit name and channel number to which this block is set will be displayed
- Band:** Click and select the band to adjust;
 - 4 Band EQ has Band 1 (80 Hz), Band 2 (315 Hz), Band 3 (1250 Hz) and Band 4 (5000 Hz)
- Equalizer type:** Click and select the equalizer type;
 - Low Shelving
 - High Shelving
 - Notch
 - Bell (default)
- Frequency:** To select the center frequency (Hz) for the current band; range is from 20 Hz to 20 kHz (1 Hz stepping)
- Gain:** To adjust the amount of boost or cut applied at the center frequency for the current band from 9 to -27 dB (0.1 dB stepping); default at 0 dB
- Quality:** Q or Quality factor, selects the ratio of the center frequency divided by the bandwidth. Q reflects an inverse relationship to the bandwidth, and adjust from 0.01 to 50.00 (0.01 stepping); default at 0.50
- Bypass:** When selected, it will bypass this filter
- Quality dot:** Q factor dot
- Frequency square:** These settings may be adjusted by dragging the band controls shown inside the graph

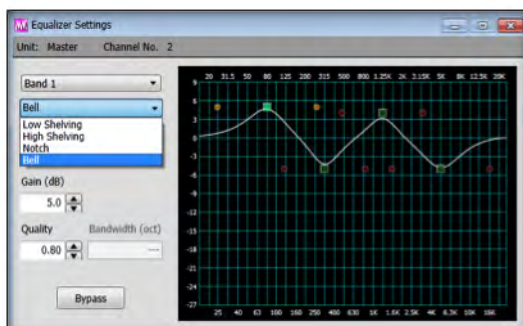
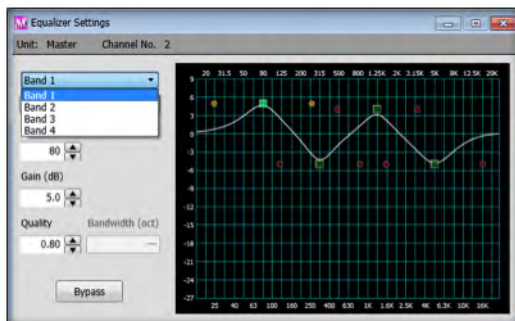

All Pass Filter Setting

Double-click "All Pass Filter" block,



the following window will be displayed

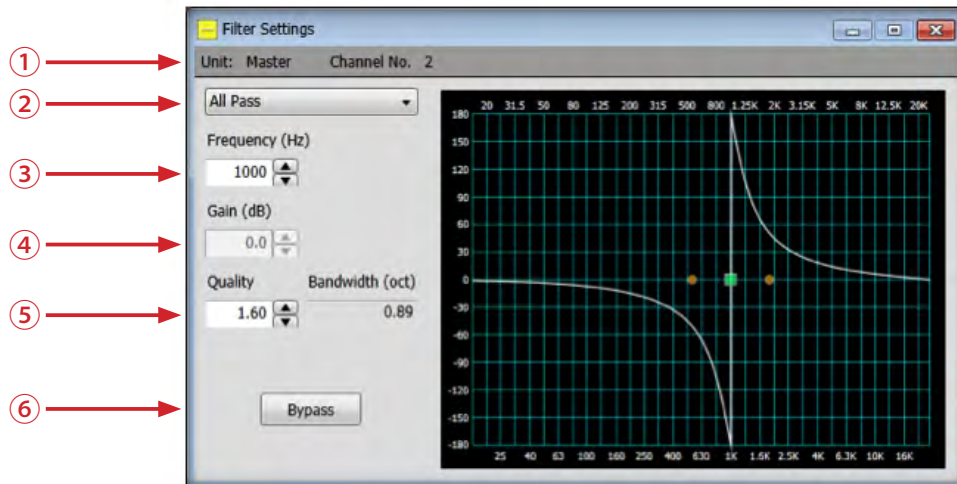

- Unit name and Channel No:** The unit name and channel number to which this block is set will be displayed
- Filter Type:** Click to change to other filter type
- Frequency:** Adjust the center frequency from 20 Hz to 20 kHz (1 Hz stepping)
- Gain:** Fixed at 0 dB (non-adjustable)
- Quality/Bandwidth:** Adjust the quality of the filter; Q from 0.20 to 4 (0.01 stepping), default at 0.5; bandwidth (oct) from 4.74 to 0.36 (0.01 stepping), default at 2.55
- Bypass:** When selected, it will bypass this filter

Notch Filter Setting

Double-click "Notch Filter" block,



the following window will be displayed

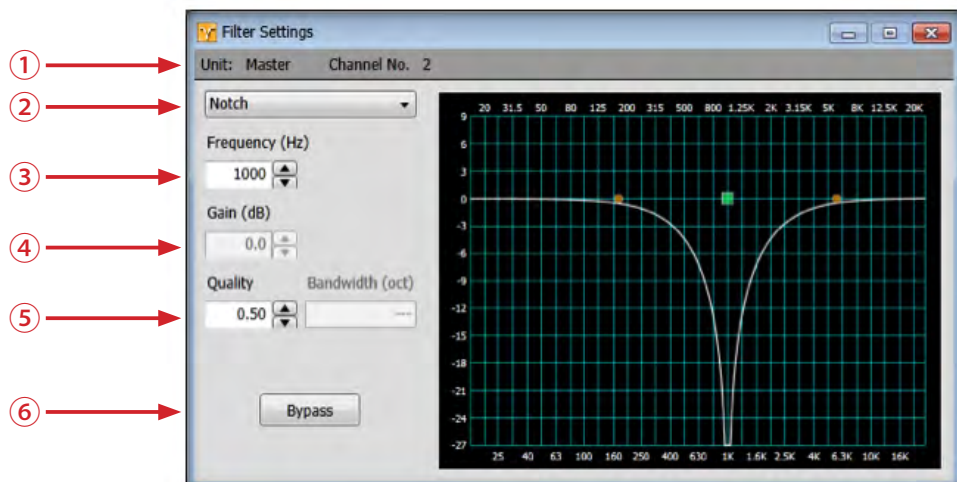

- Unit name and Channel No:** The unit name and channel number to which this block is set will be displayed
- Filter Type:** Click to change to other filter type
- Frequency:** Adjust the center frequency from 20 Hz to 20 kHz (1 Hz stepping)
- Gain:** Fixed at 0 dB (non-adjustable)
- Quality:** Adjust the quality of the filter; Q from 0.01 to 50.00 (0.01 stepping); default at 0.50
- Bypass:** When selected, it will bypass this filter

● Low Pass Filter Setting, -12 dB/oct

Double-click "Low Pass Filter" block,



the following window will be displayed

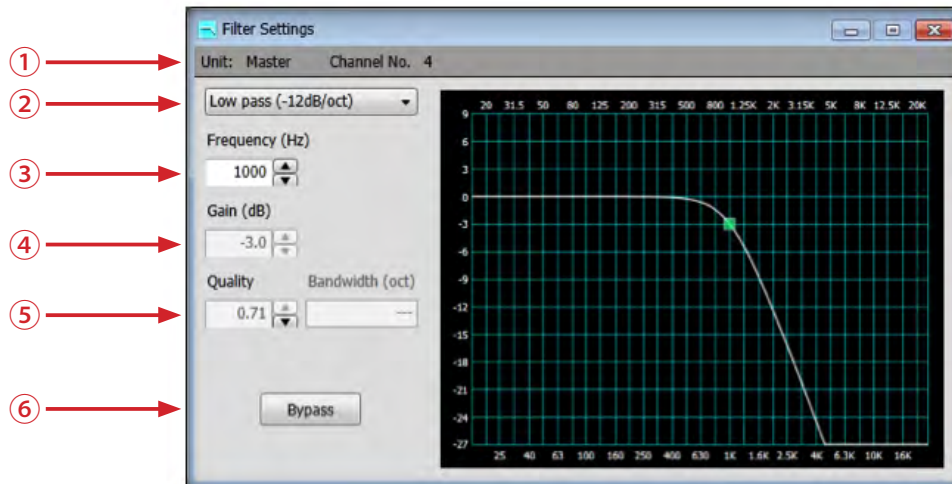

1. **Unit name and Channel No:** The unit name and channel number to which this block is set will be displayed
2. **Filter Type:** Click to change to other filter type
3. **Frequency:** Adjust the cut-off frequency from 20 Hz to 20 kHz (1 Hz stepping)
4. **Gain:** Fixed at -3 dB (non-adjustable)
5. **Quality:** Fixed at 0.71 (non-adjustable)
6. **Bypass:** When selected, it will bypass this filter

● High Pass Filter Setting, -12 dB/oct

Double-click "High Pass Filter" block,



the following window will be displayed

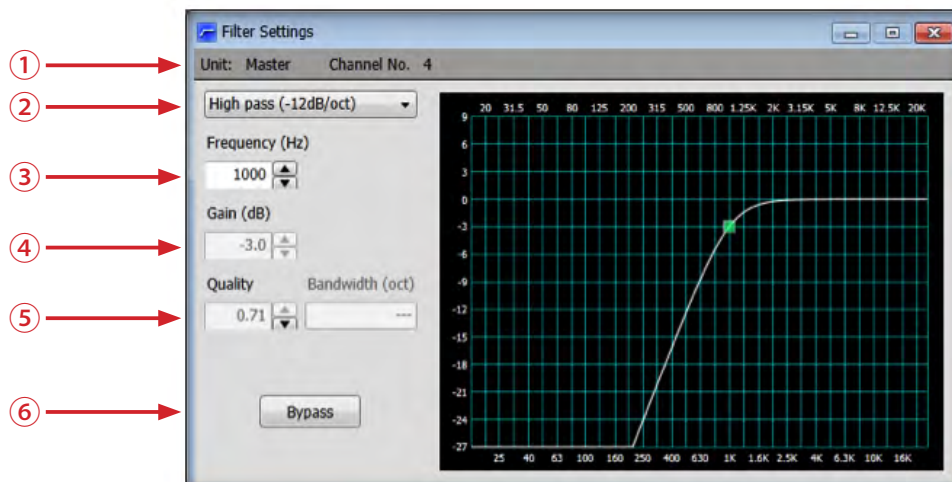

1. **Unit name and Channel No:** The unit name and channel number to which this block is set will be displayed
2. **Filter Type:** Click to change to other filter type
3. **Frequency:** Adjust the cut-off frequency from 20 Hz to 20 kHz (1 Hz stepping)
4. **Gain:** Fixed at -3 dB (non-adjustable)
5. **Quality:** Fixed at 0.71 (non-adjustable)
6. **Bypass:** When selected, it will bypass this filter

● Low Pass Filter Setting, -6 dB/oct

Double-click "Low Pass Filter" block,  the following window will be displayed

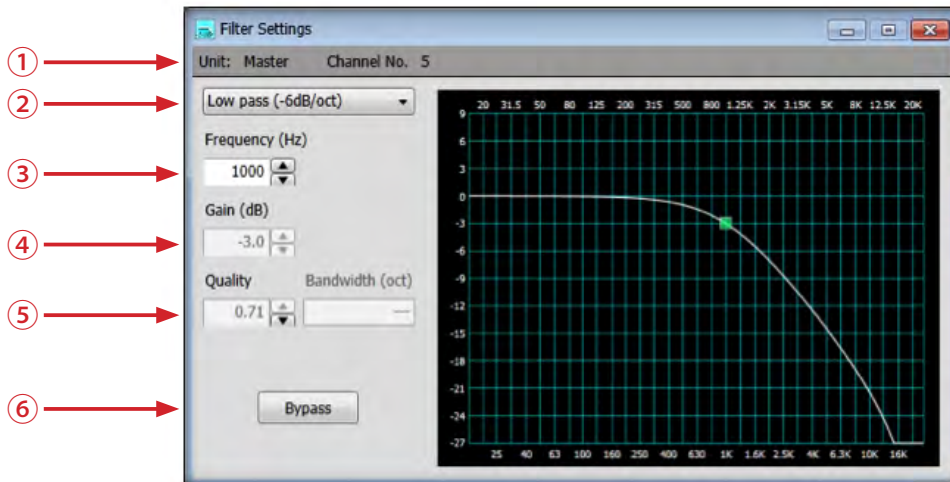

- 1. Unit name and Channel No:** The unit name and channel number to which this block is set will be displayed
- 2. Filter Type:** Click to change to other filter type
- 3. Frequency:** Adjust the cut-off frequency from 20 Hz to 20 kHz (1 Hz stepping)
- 4. Gain:** Fixed at -3 dB (non-adjustable)
- 5. Quality:** Fixed at 0.71 (non-adjustable)
- 6. Bypass:** When selected, it will bypass this filter

● High Pass Filter Setting, -6 dB/oct

Double-click "High Pass Filter" block,  the following window will be displayed

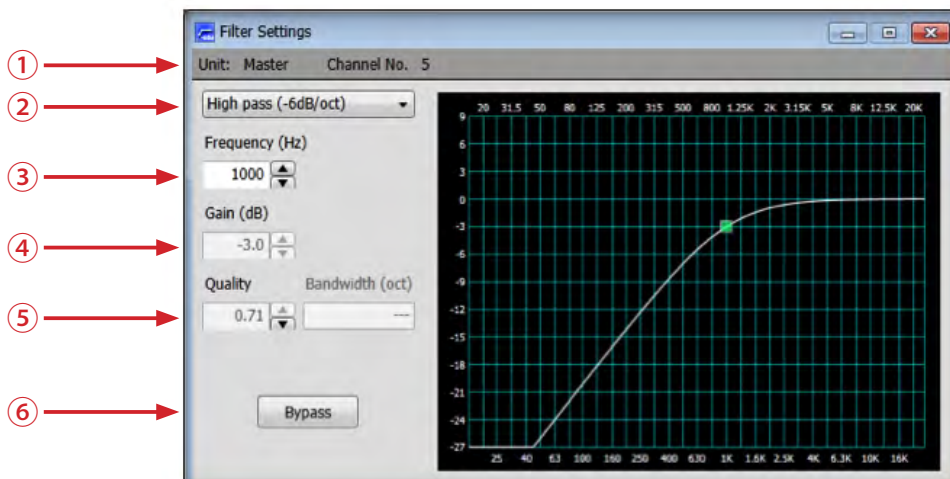

- 1. Unit name and Channel No:** The unit name and channel number to which this block is set will be displayed
- 2. Filter Type:** Click to change to other filter type
- 3. Frequency:** Adjust the cut-off frequency from 20 Hz to 20 kHz (1 Hz stepping)
- 4. Gain:** Fixed at -3 dB (non-adjustable)
- 5. Quality:** Fixed at 0.71 (non-adjustable)
- 6. Bypass:** When selected, it will bypass this filter

● Low Shelving Filter Setting

Double-click "Low Shelving Filter" block,



the following window will be displayed

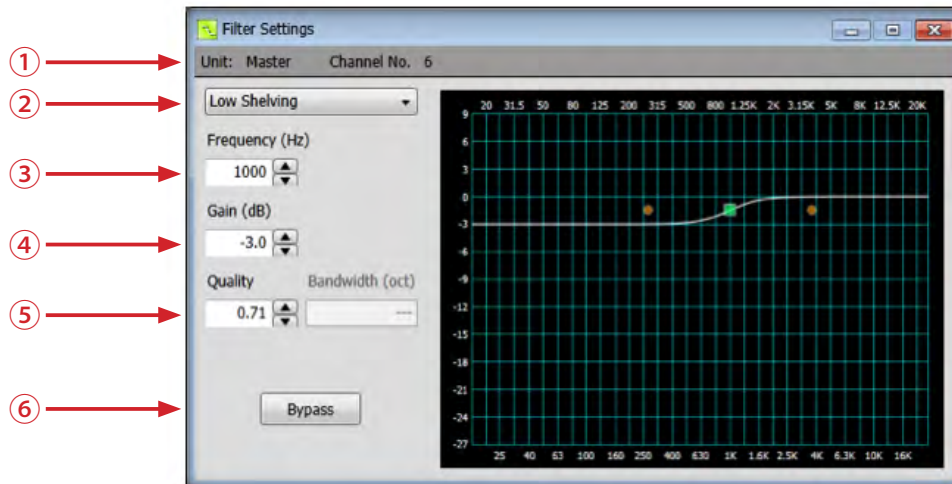

1. **Unit name and Channel No:** The unit name and channel number to which this block is set will be displayed
2. **Filter Type:** Click to change to other filter type
3. **Frequency:** Adjust the cut-off frequency from 20 Hz to 20 kHz (1 Hz stepping)
4. **Gain:** Adjust the amount of cut or boost applied by the filter; gain at 9 dB to -27 dB (0.1 dB stepping)
5. **Quality:** Adjust the quality of the band; Q from 0.01 to 1.00 (0.01 stepping)
6. **Bypass:** When selected, it will bypass this filter

● High Shelving Filter Setting

Double-click "High Shelving Filter" block,



the following window will be displayed

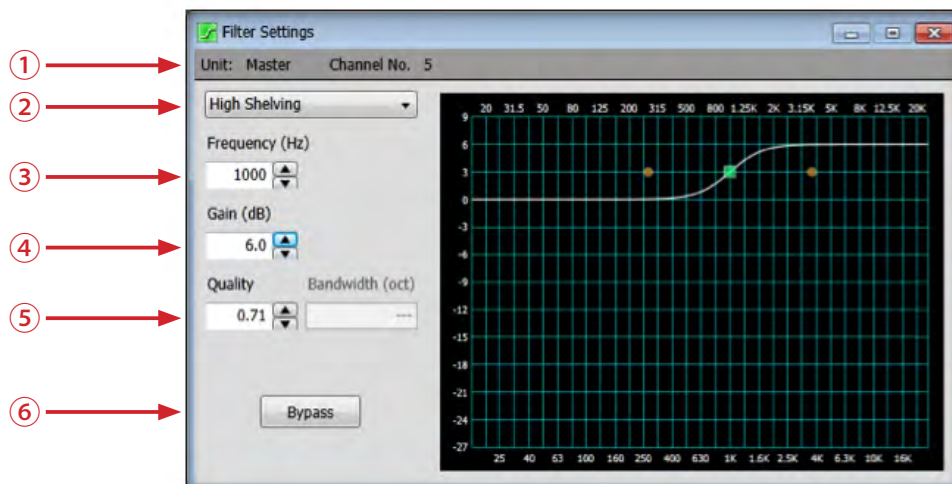

1. **Unit name and Channel No:** The unit name and channel number to which this block is set will be displayed
2. **Filter Type:** Click to change to other filter type
3. **Frequency:** Adjust the center frequency from 20 Hz to 20 kHz (1 Hz stepping)
4. **Gain:** Adjust the amount of cut or boost applied by the filter; gain at 9 dB to -27 dB (0.1 dB stepping); default at -3.0 dB
5. **Quality:** Adjust the quality of the filter, Q from 0.01 to 50.00 (0.01 stepping); default at 0.71
6. **Bypass:** When selected, it will bypass this filter

● Limiter Setting

Double-click "Limiter" block, the



following window will be displayed

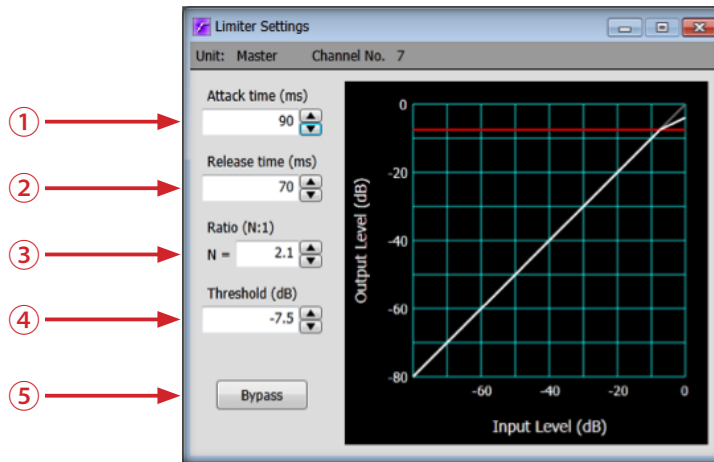

1. **Attack time:** Determines how quickly the limiter reacts to input level changes
 - Adjustable range is 0 to 2000 ms (1 ms stepping)
2. **Release time:** Determines how quickly gain reduction is released, once input signal falls below threshold.
 - Adjustable range is 0 to 2000 ms (1 ms stepping)
3. **Ratio:** Determines the intensity of gain reduction
 - Adjustable range is 1:1 to 20:1 (0.1 stepping)
4. **Threshold:** Determines what input level will trigger gain reduction
 - Adjustable range is -80 to 0 dB (0.1 dB stepping)
5. **Bypass button:** Disables the limiter without changing settings

● Delay Setting

Double-click "Delay" block, the



the following window will be displayed

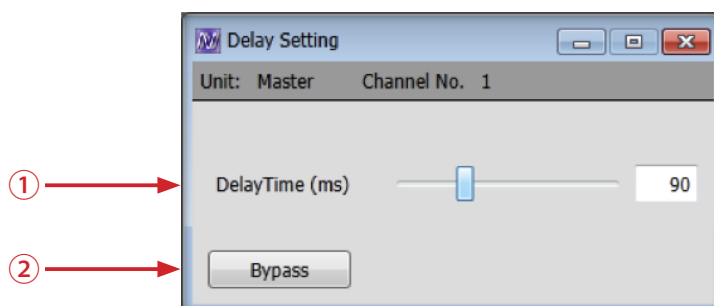

1. **Delay Time:** Determines the amount of delay
 - Adjustable range is 0 to 300ms (1 ms stepping)
2. **Bypass button:** Disables the delay without changing settings

Unit and DSP Resource Monitor

Orange color Input usage; Light Blue color Output usage

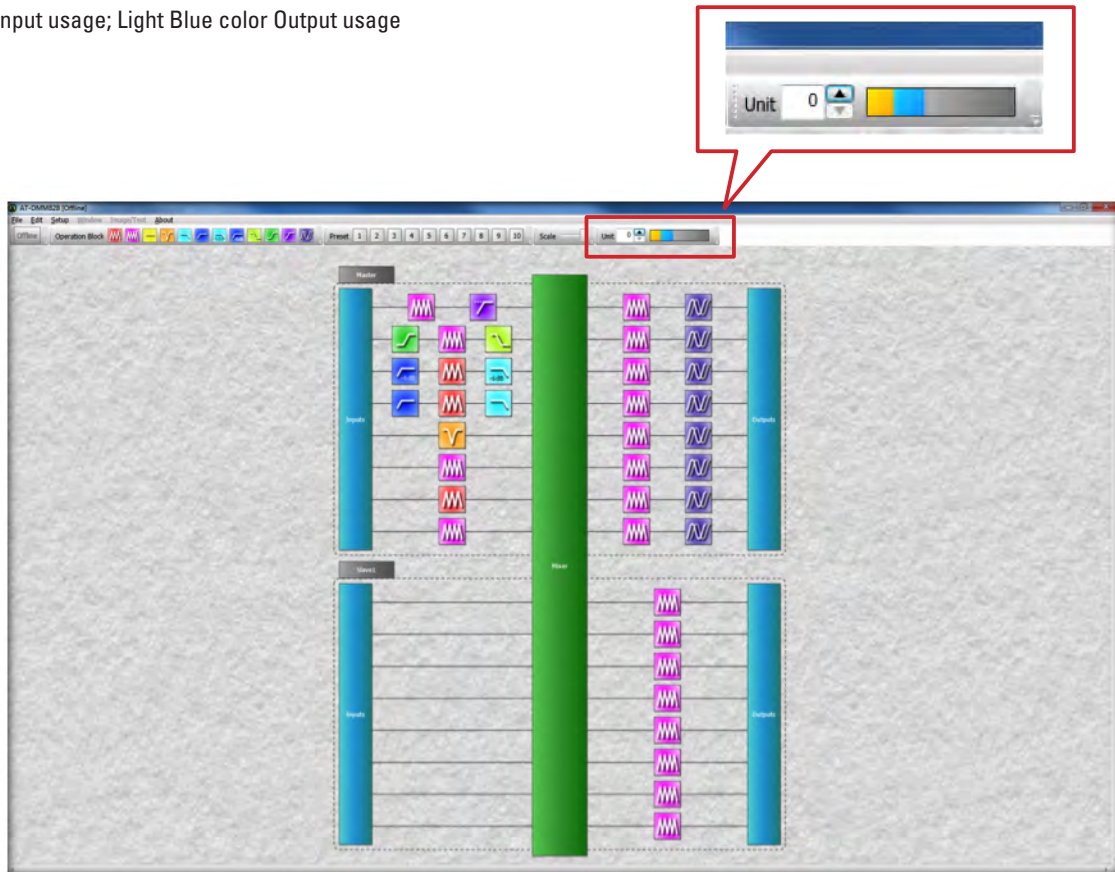

Unit 0, Master Unit, Selection and its DSP Resource Usage Display

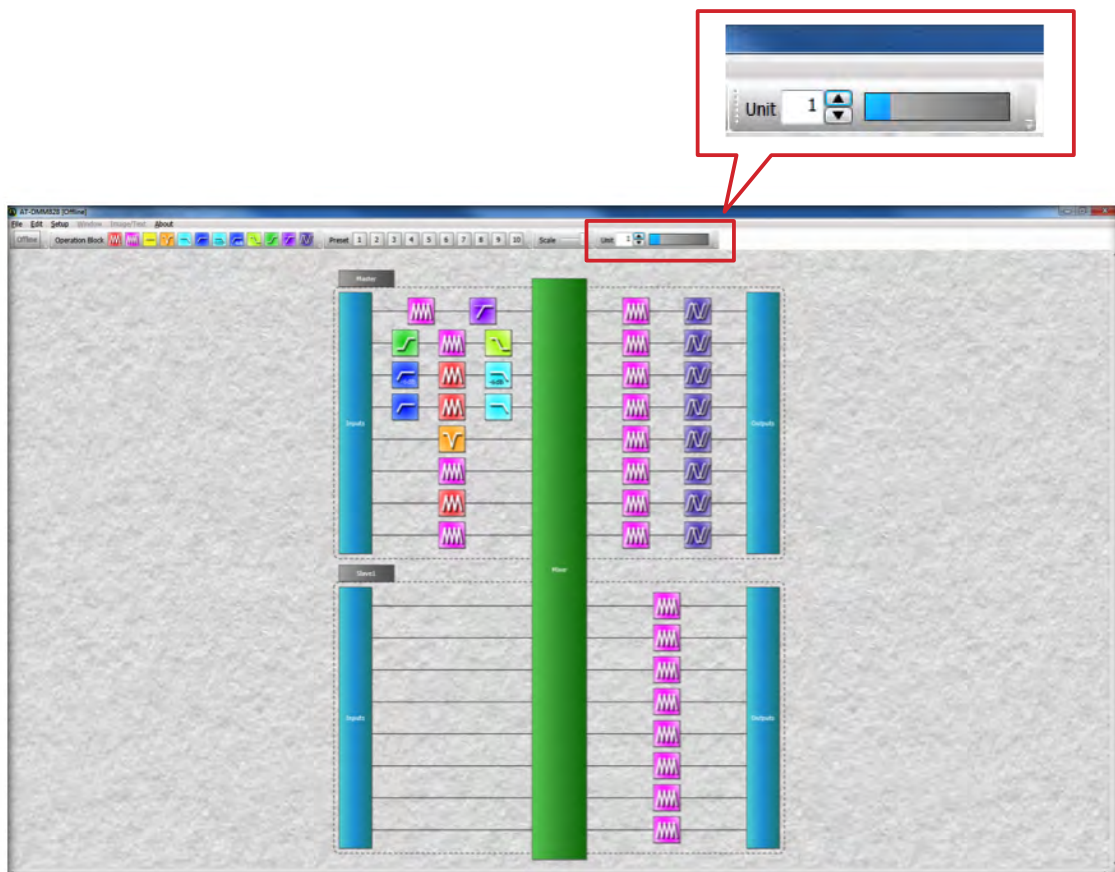

Unit 1, Slave Unit 1, Selection and its DSP Resource Usage Display

External Settings

Double-click **Master** or **Slave1** "SlaveX" icon to load and display the External Control Terminal Settings window

It must be in Offline mode to perform settings

1. **Enable/disable external control**
2. **Drop-down menu**
 Mute – ON / OFF / Toggle
 Volume - + 3.0 to -3.0 (1 dB stepping)
 Gate – ON / OFF
 VCA
 Output

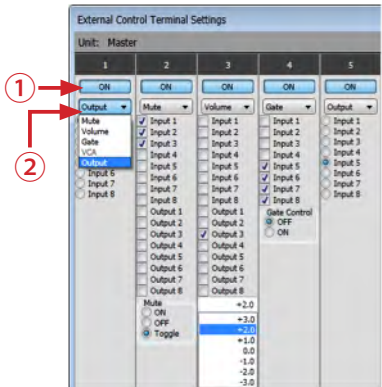

The following table show what functions is available for each pin assignment:

PIN	1	2	3	4	5	6	7	8	9	10	11	12	13	14	15	16	17	18	19	20	21	22	23	
Mute	X	X	X	X	X	X	X	X	X	X	X	X	X	X	X	X	X	X	X	X	X	X	X	X
Volume	X	X	X	X	X	X	X	X	X	X	X	X	X	X	X	X	X	X	X	X	X	X	X	X
Gate	X	X	X	X	X	X	X	X	X	X	X	X	X	X	X	X	X	X	X	X	X	X	X	X
VCA																X	X	X	X	X	X	X	X	X
Output	X	X	X	X	X	X	X	X																

External Control Connector (25-Pin D-Sub)

To increase the integration flexibility of the AT-DMM828 with external control and indicator devices, a rear panel connector (25-pin) is provide.

Pin#	Selectable Function	Pin#	Selectable Function
1	Channel status output or Gate on/off or Mute on/off/toggle or Volume up/down	2	Channel status output or Gate on/off or Mute on/off/toggle or Volume up/down
3	Channel status output or Gate on/off or Mute on/off/toggle or Volume up/down	4	Channel status output or Gate on/off or Mute on/off/toggle or Volume up/down
5	Channel status output or Gate on/off or Mute on/off/toggle or Volume up/down	6	Channel status output or Gate on/off or Mute on/off/toggle or Volume up/down
7	Channel status output or Gate on/off or Mute on/off/toggle or Volume up/down	8	Channel status output or Gate on/off or Mute on/off/toggle or Volume up/down
9	Gate on/off or Mute on/off/toggle or Volume up/down	10	Gate on/off or Mute on/off/toggle or Volume up/down
11	Gate on/off or Mute on/off/toggle or Volume up/down	12	Gate on/off or Mute on/off/toggle or Volume up/down
13	Gate on/off or Mute on/off/toggle or Volume up/down	14	Gate on/off or Mute on/off/toggle or Volume up/down
15	Gate on/off or Mute on/off/toggle or Volume up/down	16	VCA control or Gate on/off or Mute on/off/toggle or Volume up/down
17	VCA control or Gate on/off or Mute on/off/toggle or Volume up/down	18	VCA control or Gate on/off or Mute on/off/toggle or Volume up/down
19	VCA control or Gate on/off or Mute on/off/toggle or Volume up/down	20	VCA control or Gate on/off or Mute on/off/toggle or Volume up/down
21	VCA control or Gate on/off or Mute on/off/toggle or Volume up/down	22	VCA control or Gate on/off or Mute on/off/toggle or Volume up/down
23	VCA control or Gate on/off or Mute on/off/toggle or Volume up/down	24	+3.3V (for VCA control)
25	GND		

To activate mute-on/mute-off, volume-up/volume-down and gate-on/gate-off, install a closure between the appropriate pin and +3.3V Reference on the External Control connector (24pin) on back of unit.

NOTE:

Audio-Technica legacy mixer provides the external control function which uses a "Low Active" (Ground Reference). AT-DMM828's external control function uses a "High Active" (+3.3V Reference).

If you need to use a Low Active switch function, you need to add the following circuit.

Low Active interface circuit:

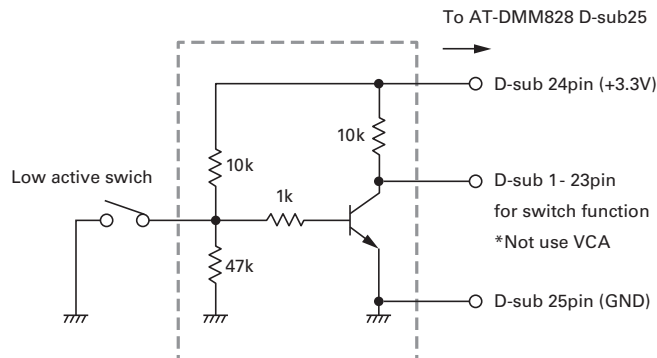

Input Channel Settings

Double-click "Inputs" block, the following window will be displayed

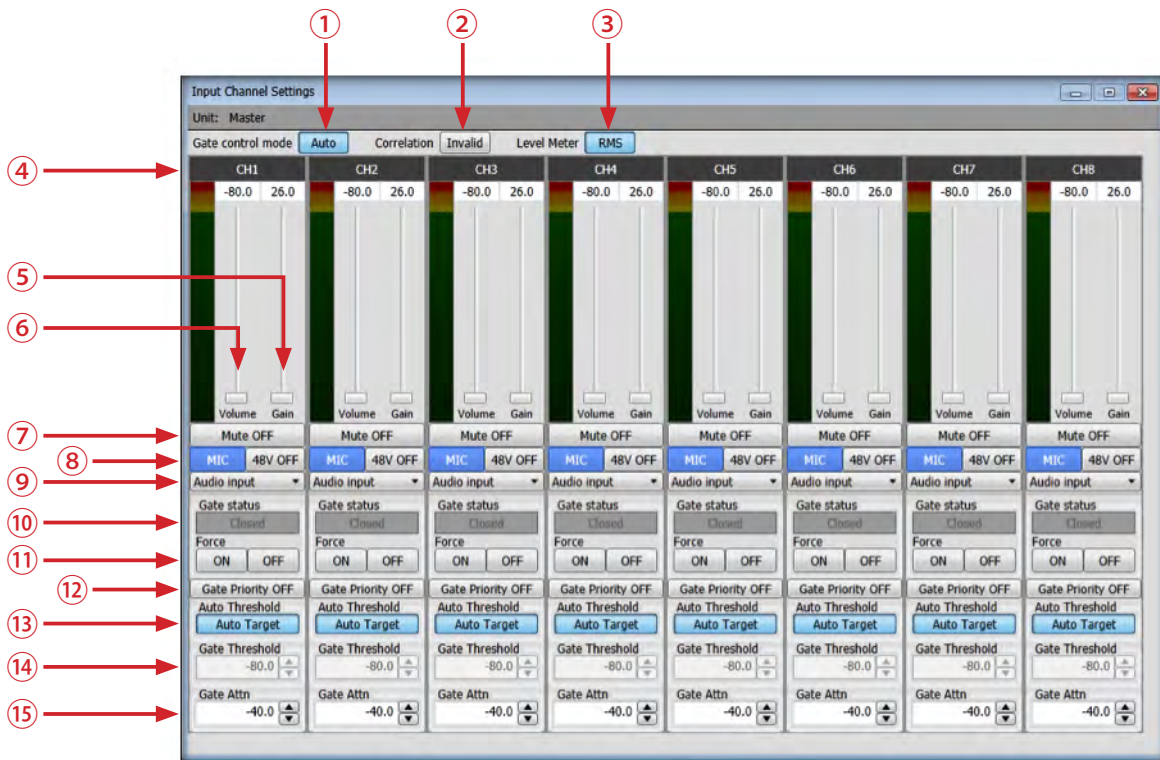

1. **Gate control mode:** To select Auto or Manual mode
2. **Correlation:** To select Valid or Invalid
Correlation of an input signal is judged and gate control of a contiguity channel is performed
A judgment is performed in each unit
3. **Input level meter response:** To select RMS or PEAK metering
4. **Channel name:** To edit, double click the name and edit
5. **Gain:** Adjustable range is 26 to 51 dB (32 steps logarithmic scale)
6. **Volume:** Adjustable range is -80 to 0 dB (0.1 dB stepping)
7. **Mute button:** To mute each input channel
8. **Input Attenuator and Phantom Power:** Select either MIC or LINE. LINE is already attenuated 30 dB
Select the phantom power (+48V) ON/OFF
9. **Input source:** To select input source Audio input or White noise /Pink noise /Tone (for channel calibration)
10. **Gate status:** The gate status of the channel is indicated
11. **Force-On/OFF button:** To force the gate open or closed via software.
12. **Gate priority:** Set priority to each channel
13. **Auto Target:** To select ON or OFF mode, the channel which is set "Auto Target" – "ON" mode: it becomes the calculation target for the gate threshold in Auto mode
14. **Gate Threshold:** Adjustable range is -80 to 0 dB in Manual mode (0.1 dB stepping)
15. **Gate Attenuation:** Set attenuation level for Mic-Off; adjustable range is -80 to 0 dB (0.1 dB stepping)

Matrix Settings

Double-click "Mixer" block, the following window will be displayed

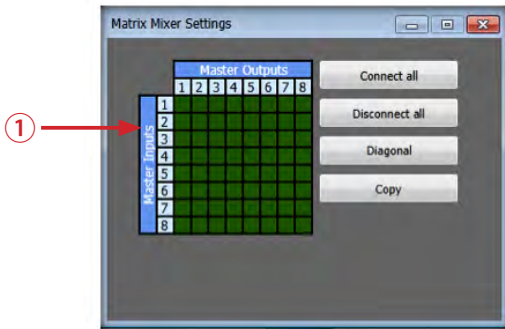

1. **Matrix Figure:** Right-click on the point, to select the matrix connect or disconnect
 Green color represents connection; pink color represents no connection
 Left-click on one of the squares, to adjust the sending level on the matrix
 Sending level range is -80 to 0 dB (0.1 dB stepping)
 When lower the sending level, the color of the squares will lighten gradually to white color at 0 dB

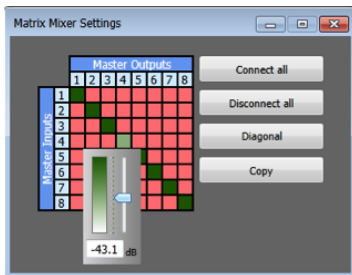
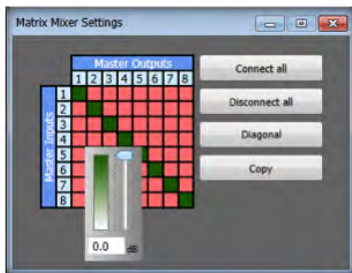

2. There are 4 select buttons next to the Master Matrix block
 - a. **Connect all:** when click on this button, all input channels are connected to all output channels

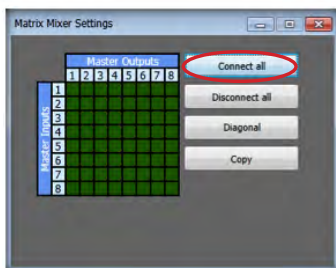

- b. **Disconnect all:** when click on this button, all input channels are disconnected to all output channels; there is no output

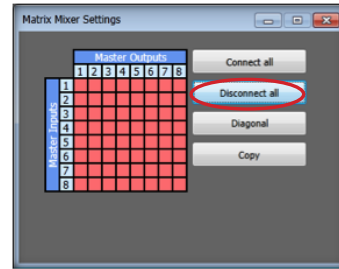

- c. **Diagonal:** when click on this button, each input channel is only connect to one respective output channel

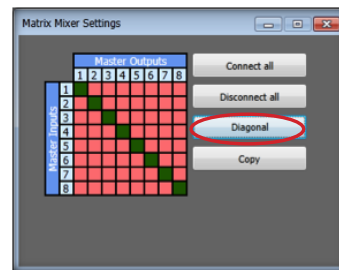

- d. **Copy:** this button is for 2 or more units linking together

- when 2 or more units, the Matrix Mixer Settings window will have additional matrix block that mark as Slave input block linking to Master outputs, as show below



- Click the Copy button, the following window will display to allow selection any of the connecting unit copy to other connecting unit within the linking system

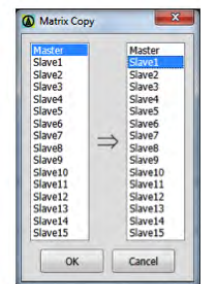

- Click the Slave Output bar will display the output connection within its own slave unit and from the slave unit or units connecting below

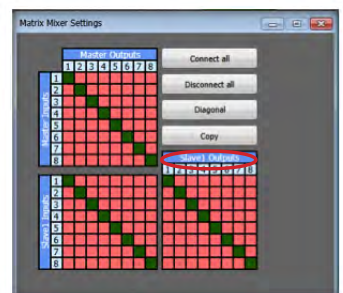

Output Channel Settings

Double-click "Outputs" block, the following window will be displayed

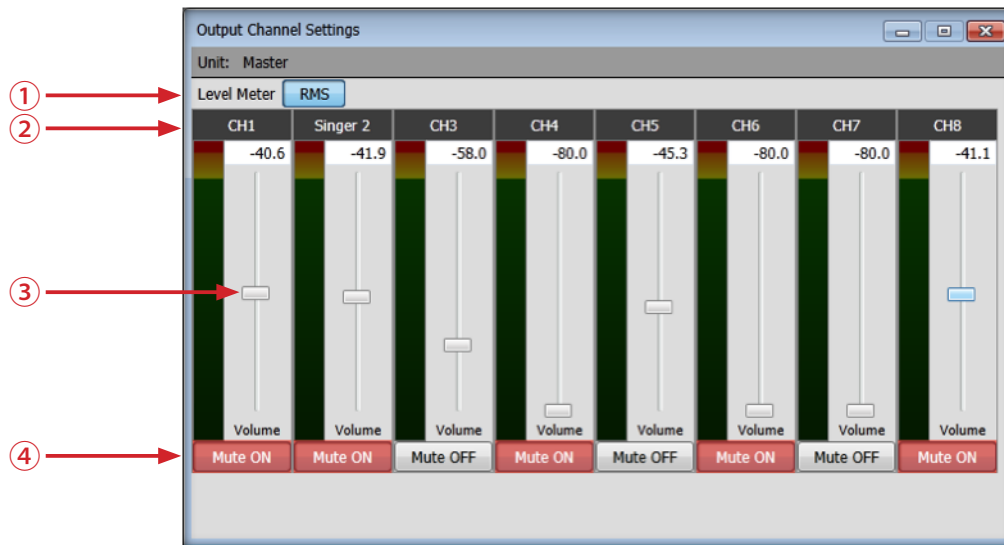

1. **Output level meter response:** To select the RMS or PEAK metering
2. **Channel name:** To edit, double click the name and edit
3. **Volume:** Adjustable range is -80 to 0 dB (0.1 dB stepping)
4. **Mute button:** To mute each output channel

When 2 or more units linking together, the Main Window will display as follow:

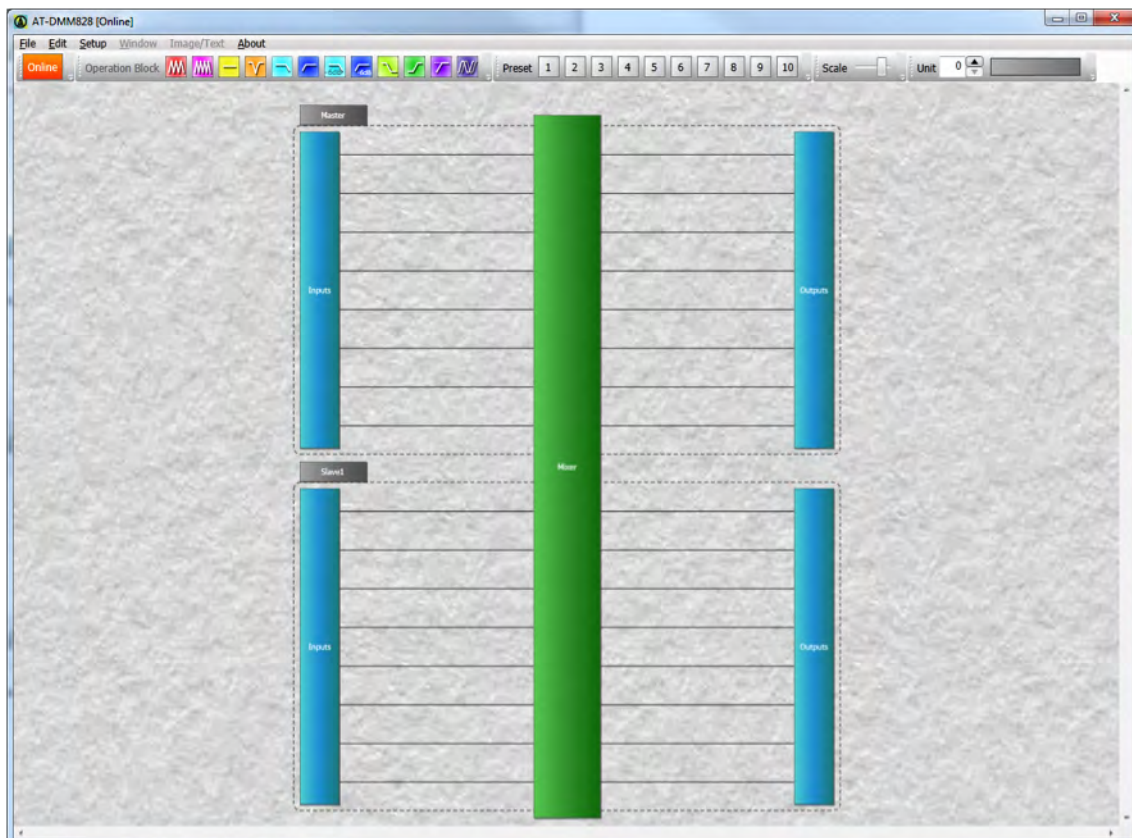

AT-DMM828 Quick Setup Tips

1. Connect a microphone to input and connect the other equipment (amplifier-speaker etc...) to output
2. Connect the power cord to the mixer and plug it to an AC outlet
3. Connect the USB cable to the mixer and PC
4. Turn Power Switch "ON"
5. Start the AT-DMM828 Control Software
6. Select "File" > "Open"> "DEMO.dmm828"
Then the default block setting will be displayed
7. Select "Setup" > "Communication Settings" or Double-clicking "Offline" icon

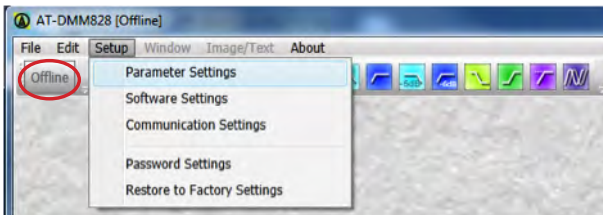

The following window show up



8. Click the "USB Communication's Connect" button
The following either one of the 2 dialogs will come up, select "Yes" button
 - A setup will be reflected in a mixer, if it shifts to online mode after arranging an operation block.

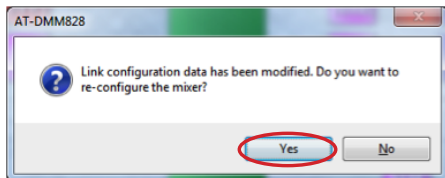

- If "YES" is chosen, a setup of PC application will be overwritten by the mixer.
- The following dialog is displayed when only a parameter is different by the case where the composition of the present mixer is the same as that of PC application.

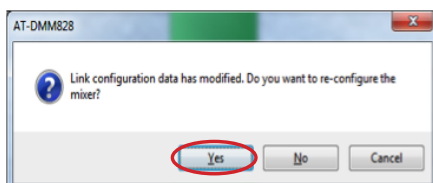

- If "YES" is chosen, a setup of PC application will be overwritten by the mixer.
- If "NO" is chosen, a setup of the present mixer will be read on PC application.

"Offline" icon will change "Online" icon if it connects normally

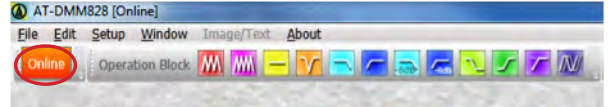

9. Double-click "Inputs" block, the input setting window will be displayed

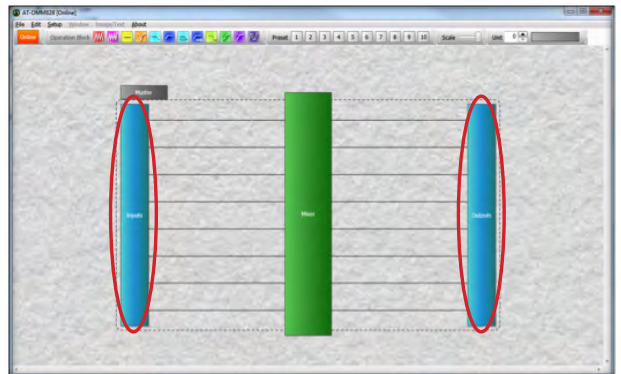

10. Set the input volume, gain level and phantom power

11. Double-click "Outputs" block, the output setting window will be displayed

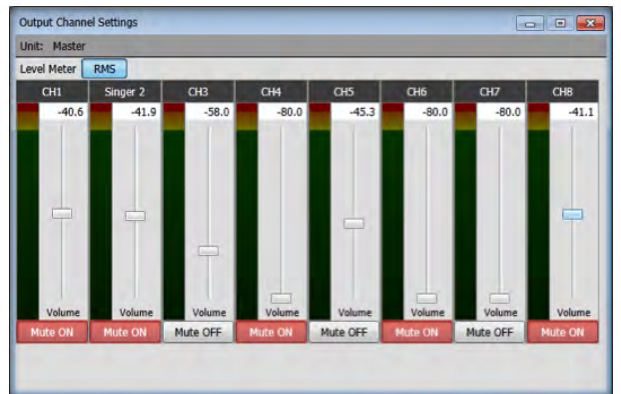

12. Set output level

* EQ or Filters and some additional blocks can be added in offline mode. (Refer to "Customize the DSP block")

Specifications

Input Impedance Balanced		
Mic	6600 ohms	
Line	8500 ohms	
Output Impedance Balanced	200 ohms	
Gain Range	26 to 51 dB	32 steps logarithmic scale
Mic/Line Input Attenuation	30 dB	
Maximum Input Level		Balanced, THD+N at 1 %
Mic	-45 dBu (-47.2 dBV)	Gain at Max
	-20 dBu (-22.2 dBV)	Gain at Min
Line	-15 dBu (-17.2 dBV)	Gain at Max
	+10 dBu (+7.79 dBV)	Gain at Min
Maximum Output Level	+24 dBu (+21.8 dBV)	Balanced, THD+N at 1%
Maximum Gain	+66 dB	Balanced-in to balanced-out
THD+N	less than 0.05%	20 to 22,000 Hz BW filter +4 dBu signal, unity gain
Dynamic Range	102 dB	A-weighted, referenced +24 dBu, Rs = 150 ohm input
Frequency Response	20 to 20,000 Hz	±3 dB referenced at 1k Hz
Equivalent Input Noise	-117.8 dBu (-120 dBV)	Gain at Max A-weighted, Rs = 150 ohm input
Maximum NOMA Attenuation	≈20 dB (up to 100 mics on simultaneously)	
Microphone Phantom Power	+48V DC ±2V DC	
Control Voltage Out	+3.3V DC	
Latency	1ms	Propagation delay from input to output
Power Supply	100-240V AC, 50/60 Hz, 25W	
Operating Temperature	0° to 40° C (32° to 104° F)	
Dimensions	482 x 230 x 44 mm (19 x 9.05 x 1.75") W x D x H (Not including feet, knobs and connectors)	
Weight	2.4 kg (5 lbs. 4.5 oz.)	
Accessories Included	AC power cord	
DIGITAL		
SAMPLE RATE	48 kHz	
QUANTIZATION	24-bit Delta-sigma ADC and DAC	
DIGITAL PROCESSING	Uses two TI TMS320™ DSP	
DSP CPU Speed Range	266 MHz	