



3000 Series

User Manual UHF Wireless Systems

ATW-R3210
Receiver

ATW-T3201 / ATW-T3201a
Body-Pack Transmitter

ATW-T3202 / ATW-T3202a
Handheld Transmitter

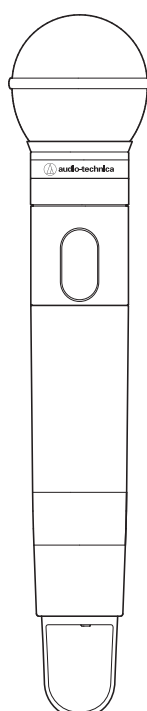
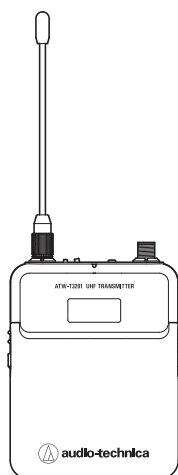
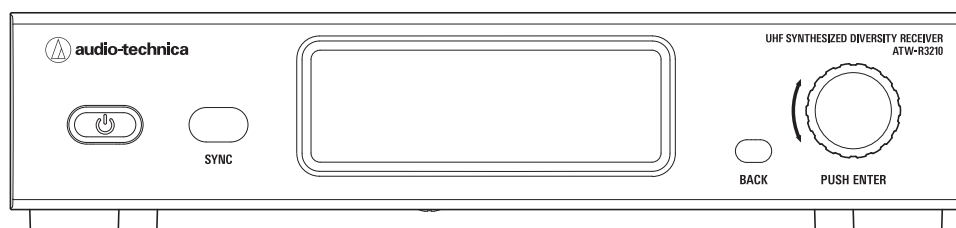

Contents

Introduction	2	Troubleshooting	26
Important information	2	ATW-R3210	26
Notes on use	3	ATW-T3201 / ATW-T3201a / ATW-T3202 / ATW-T3202a	26
Maintenance	3	Dimensions	27
Part names and functions	4	ATW-R3210	27
ATW-R3210	4	ATW-T3201 / ATW-T3201a	28
ATW-T3201 / ATW-T3201a	6	ATW-T3202 / ATW-T3202a	28
ATW-T3202 / ATW-T3202a	7	Specifications	29
How to insert batteries	8	Overall system specifications	29
ATW-T3201 / ATW-T3201a	8	ATW-R3210	29
ATW-T3202 / ATW-T3202a	8	ATW-T3201 / ATW-T3201a	30
How to attach and detach the interchangeable microphone capsule (only for ATW-T3202 / ATW-T3202a)	9	ATW-T3202 / ATW-T3202a	30
How to attach	9		
How to remove	9		
How to read the display	10		
ATW-R3210	10		
ATW-T3201 / ATW-T3201a / ATW-T3202 / ATW-T3202a	12		
How to operate	13		
Basic operation	13		
Using IR SYNC	13		
Settings	14		
ATW-R3210	14		
ATW-T3201 / ATW-T3201a / ATW-T3202 / ATW-T3202a	14		
Setting ATW-R3210	15		
List of setting items	15		
Setting the operating frequency	15		
Setting the channel (receiver) name	15		
Setting the audio output level	16		
Scanning for open channels	16		
Setting transmitters via IR SYNC	16		
Setting the squelch level	17		
Setting the system-related functions	17		
Setting ATW-T3201 / ATW-T3201a / ATW-T3202 / ATW-T3202a	20		
List of setting items	20		
Setting the transmission frequency	20		
Setting the channel (transmitter) name	20		
Adjusting the gain	21		
Setting the RF power	21		
Setting HPF (High-Pass Filter)	21		
Setting lock	21		
Setting the function for the function button	21		
Setting the mute mode (only for ATW-T3201 / ATW-T3201a)	22		
Setting the system-related functions	22		
How to attach the transmitter (ATW-T3201 / ATW-T3201a)	24		
Making connections (basic connections)	24		
Achieving stable reception	25		
Rack-mounting the receiver	25		

Introduction

Thank you for purchasing this Audio-Technica product.

Before using the product, read through this user manual to ensure that you will use the product correctly. Please keep this manual for future reference.

Important information

Warning:

- To prevent fire or shock hazard, do not expose this apparatus to rain or moisture.

Caution:

- Do not expose this apparatus to drips or splashes.
- To avoid electric shock, do not open the cabinet.
- Refer servicing to qualified personnel only.
- Do not expose this apparatus to excessive heat such as that generated by sunshine, fire or other heat sources.
- Do not subject this apparatus to strong impact.
- This apparatus should be located close enough to the AC outlet so that you can easily grasp the AC adapter at any time.
- In case of emergency, disconnect the AC adapter quickly.
- Do not place any objects filled with liquids, such as vases, on this apparatus.
- To prevent fire, do not place any naked flame sources (such as lighted candles) on this apparatus.
- Do not install this apparatus in a confined space such as a bookcase or similar unit.
- Install this apparatus only in the places with good ventilation.
- The rating label is put on the bottom of this apparatus.

Battery caution:

- Keep batteries out of the reach of children.
- Observe correct polarity as marked.
- Do not expose the battery to excessive heat such as sunshine, fire or the like.
- Always consider the environment issues and follow local regulations when disposing of batteries.
- Remove depleted battery immediately.
- Danger of explosion if battery is incorrectly replaced. Replace only with the same or equivalent type.
- Use only disposable LR06(AA) alkaline or NiMH batteries.
- Do not use new batteries and old one at the same time.
- Do not use different battery types or models.
- Do not use a leaking battery. If battery leakage occurs, avoid contact with skin. If contact occurs, immediately wash thoroughly with soap and water.
- If battery leakage comes into contact with your eyes, immediately flush with water and seek medical attention.

For customers in the USA

FCC Notice

Warning:

This device complies with Part 15 of the FCC Rules. Operation is subject to the following two conditions: (1) This device may not cause harmful interference, and (2) this device must accept any interference received, including interference that may cause undesired operation.

Caution:

You are cautioned that any changes or modifications not expressly approved in this manual could void your authority to operate this equipment.

Note: This equipment has been tested and found to comply with the limits for a Class B digital device, pursuant to part 15 of the FCC Rules. These limits are designed to provide reasonable protection against harmful interference in a residential installation. This equipment generates, uses and can radiate radio frequency energy and, if not installed and used in accordance with the instructions, may cause harmful interference to radio communications. However, there is no guarantee that interference will not occur in a particular installation. If this equipment does cause harmful interference to radio or television reception, which can be determined by turning the equipment off and on, the user is encouraged to try to correct the interference by one or more of the following measures:

- Reorient or relocate the receiving antenna.
- Increase the separation between the equipment and receiver.
- Connect the equipment into an outlet on a circuit different from that to which the receiver is connected.
- Consult the dealer or an experienced radio/TV technician for help.

Contact:

Responsible Company: Audio-Technica U.S., Inc.
Address: 1221 Commerce Drive, Stow, Ohio 44224, USA
Tel: 330-686-2600

For customers in Canada

IC statement

CAN RSS-Gen/CNR-Gen

This device complies with INDUSTRY CANADA R.S.S. 210. Operation is subject to the following conditions: (1) This device may not cause harmful interference and (2) this device must accept any interference received, including interference which may cause undesired operation.

This device complies with RSS-102 radiation exposure limits set forth for an uncontrolled environment.

Notes on use

- Be sure to read the user manual for any microphone or cable that you attach to the product.
- Disconnect the AC adapter from the outlet when this product is not in use.
- Turn off the power of this product before connecting or disconnecting cables.
- If you use the product near a TV or radio antenna, you may hear unwanted noise in the television or radio. If this occurs, move the product away from the device.
- Two waves of the same frequency can't be used simultaneously.
- Be careful of interference noise caused by the surrounding radio wave environment and use of multiple systems.
- Wireless systems may be affected by the spark noise of vehicles, dimmer of lighting apparatus, computers, office automation apparatus and electronic musical instruments. Place and use the product where it is less likely to be affected by the above.
- Be sure to use this product in combination with components specified by our company.
- Be sure the connected cable is plugged all the way into the product.
- When you connect the product with a mixer, turn off the phantom power source.
- If you use the product close to an electronic or communications device (such as a mobile phone), the product may produce unwanted noise. If this occurs, move the product away from the device.
- When setting up the product, make sure there are no obstacles between the transmitter and the receiver that might block the signal.
- To prevent the batteries from wearing out, turn the transmitter off when not in use.
- Over time, discoloration may occur due to ultraviolet rays (especially direct sunlight) and friction.
- It is legally prohibited to dismantle and modify this product. In addition, this product is so precisely manufactured that dismantling it could cause electric shock, failure or fire. Never dismantle this product.

Using multiple wireless systems

- If you use more than one device at the same time, use them in the same group.
- When using multiple units simultaneously, maintain 1 meter or more between individual transmitters and 3 meters or more between transmitters and receivers' antennas.
- When using multiple units, power on transmitters one by one, making sure there is no unwanted noise.
- When a howling (beeping or squealing) sound is produced during use, turn down the output volume of the connected mixer/amplifier.

Maintenance

- If the product becomes stained or covered with dust, be sure to disconnect the power plug before wiping it off with a dry and soft cloth.
- Do not use benzine, thinner or electrical contact cleaner, etc. They may deform or otherwise damage the product, or cause operational failure.

Part names and functions

ATW-R3210

Front panel

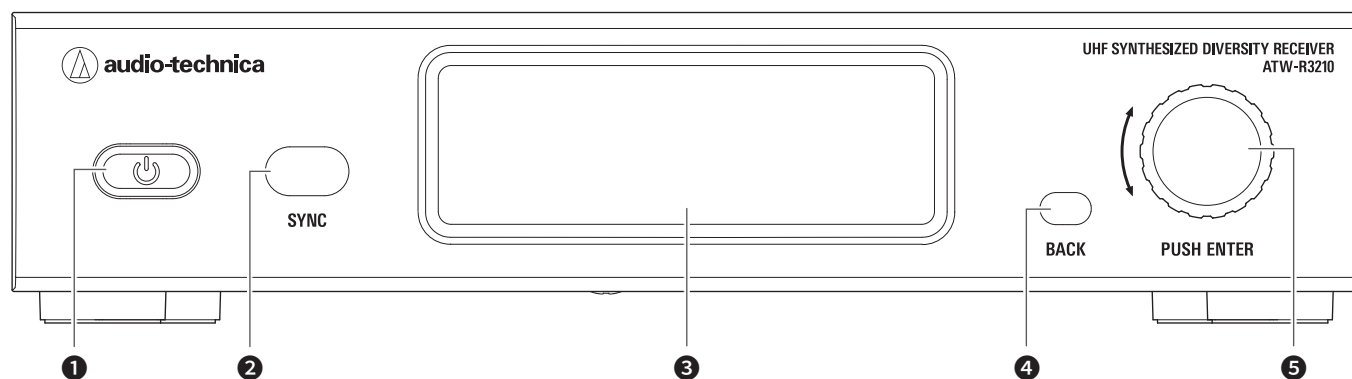

- 1** Power button ()
Use to turn the receiver on or off.
- 2** IR sync window
Use to IR SYNC with the transmitter (ATW-T3201, ATW-T3201a, ATW-T3202, ATW-T3202a).
- 3** Display
Displays the receiver state and setting menus.
- 4** BACK button
Press to take the display back one screen.
Returns to the Main screen when pressed and held.
- 5** Control dial
Switches the screen when you turn the dial.
Displays the setting menu when you press the dial. Turn the dial to select a setting and press to confirm.
When you press and hold the dial, QUICK SYNC is started.

Part names and functions

Rear panel

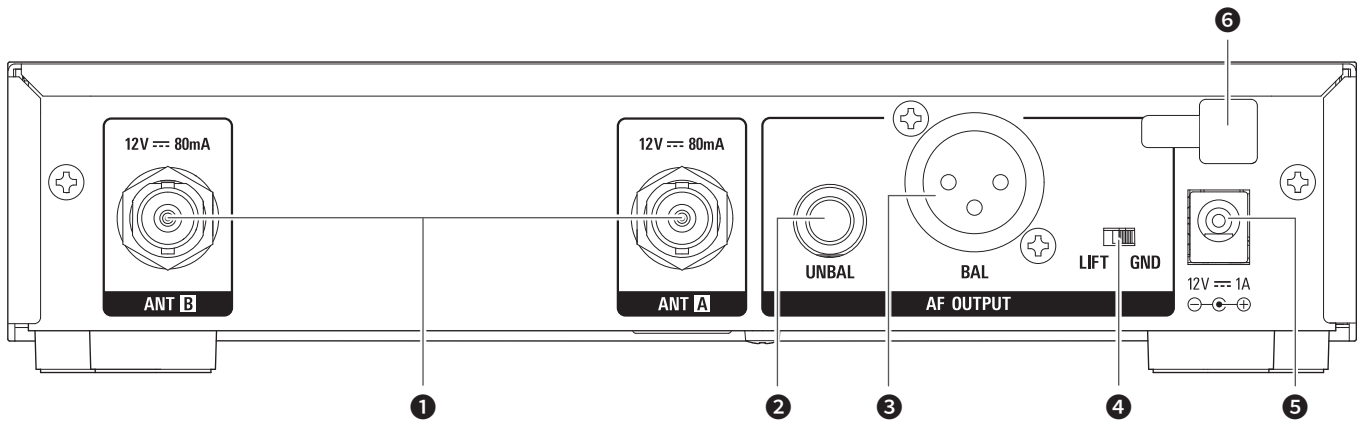

- 1** Antenna input jack
Each jack supplies DC12 V to a connected antenna.
Additionally other compatible accessories (sold separately) can be connected.
- 2** Unbalanced output terminal (6.3 mm mono jack)
- 3** Balanced output jack
(XLR 3-pin male)

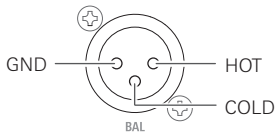

- 4** Ground lift switch
This switch isolates the GND pin of the balanced/unbalanced output from the ground.
Normally this is kept in the GND position, but if a hum develops due to a ground loop, switch to the LIFT side.
- 5** DC input terminal
Connect DC plug from the included AC adapter.
- 6** AC adapter cord hook
Hang the power cord of the AC adapter to prevent it from pulling loose accidentally.

Part names and functions

ATW-T3201 / ATW-T3201a

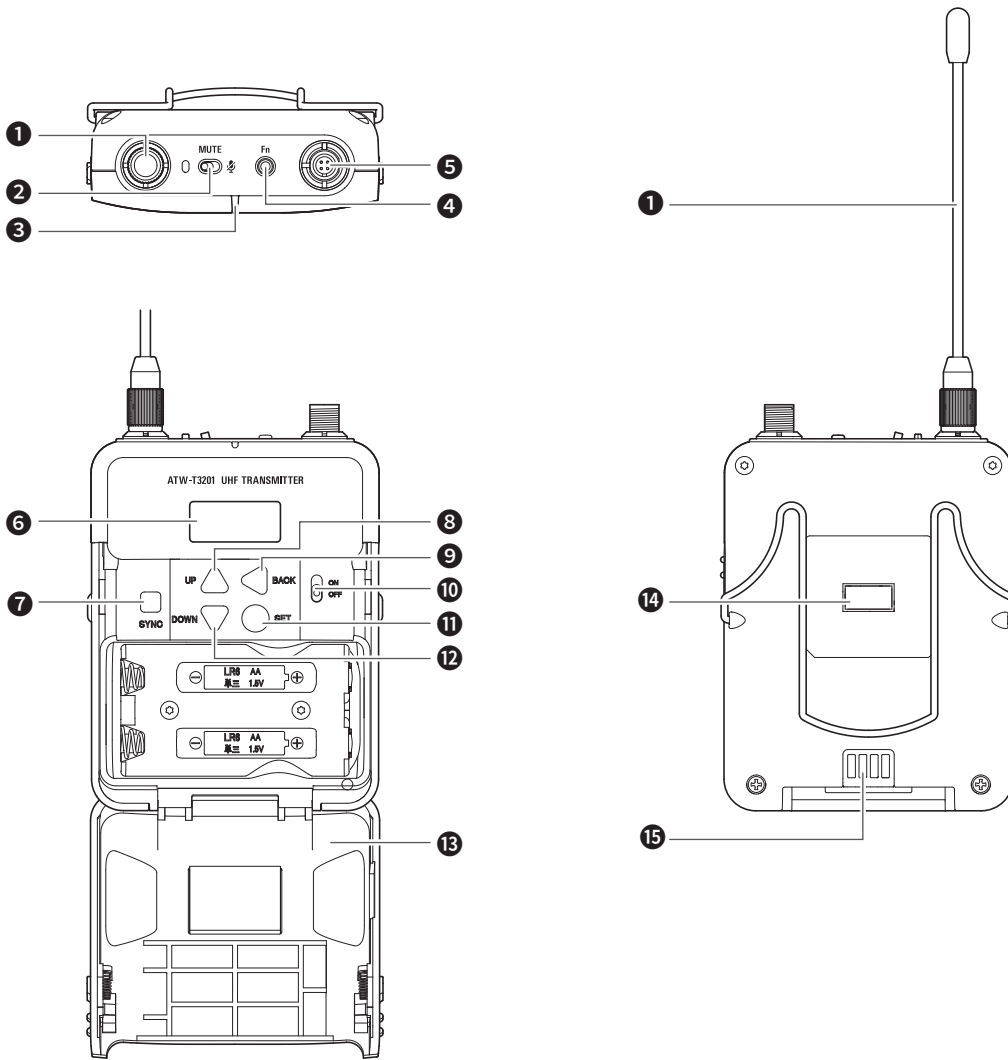

- 1** Transmission antenna
- 2** MUTE switch
Switches audio mute on and off.
- 3** Indicator
LED that shows the status of the transmitter.
When the power is turned ON: Solid green
When the transmitter is muted: Solid red
- 4** Function button
Press briefly to turn the screen back on if it shuts off. When the function is set, the preselected operation is performed.
- 5** Input connector
Connect a microphone, a headworn microphone, a guitar cable, etc.

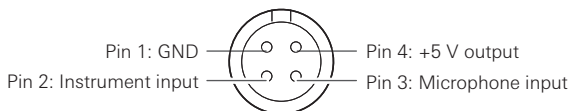

- 6** Display
Shows the current status.
If no buttons are pressed for a period of 30 seconds, the display will turn off.

- 7** SYNC button
Use to IR SYNC with the receiver (ATW-R3210).
- 8** UP button
Use to select various settings.
- 9** BACK button
Press to return to the previous screen.
Returns to the Main screen when pressed and held.
- 10** Power switch
Use to turn the power on or off.
- 11** SET button
Press to confirm a selection.
- 12** DOWN button
Use to select various settings.
- 13** Battery cover
- 14** IR sync window
Use to IR SYNC with the receiver (ATW-R3210).
- 15** Charging terminal

Part names and functions

ATW-T3202 / ATW-T3202a

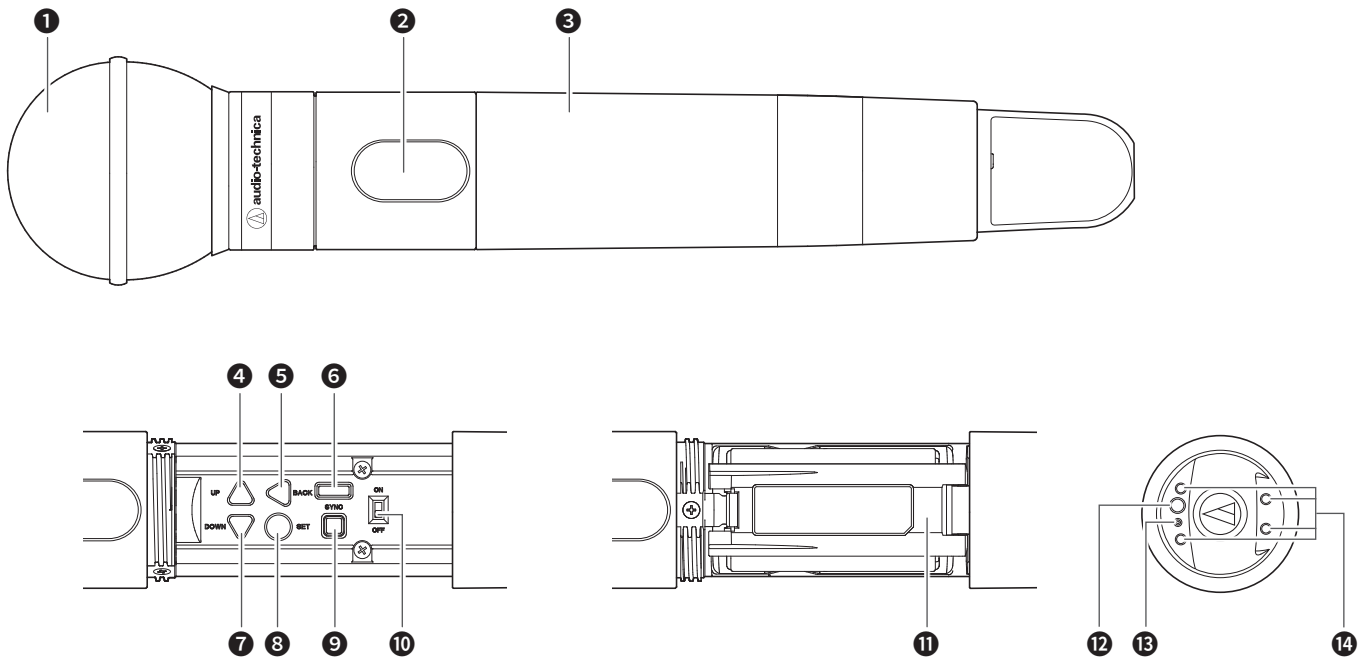

- 1** Interchangeable microphone capsule
- 2** Display
Shows the current status.
If no buttons are pressed for a period of 30 seconds, the display will turn off.
- 3** Grip case
- 4** UP button
Use to select various settings.
- 5** BACK button
Press to return to the previous screen.
Returns to the Main screen when pressed and held.
- 6** IR sync window
Use to IR SYNC with the receiver (ATW-R3210).
- 7** DOWN button
Use to select various settings.
- 8** SET button
Press to confirm a selection.
- 9** SYNC button
Use to IR SYNC with the receiver (ATW-R3210).
- 10** Power switch
Use to turn the power on or off.
- 11** Battery cover
- 12** Function button
Press briefly to turn the screen back on if it shuts off. When the function is set, the preselected operation is performed.
- 13** Indicator
LED that shows the status of the transmitter.
When the power is turned ON: Solid green
When the transmitter is muted: Solid red
- 14** Charging terminal

How to insert batteries

ATW-T3201 / ATW-T3201a

1. Slide the battery cover latches down.

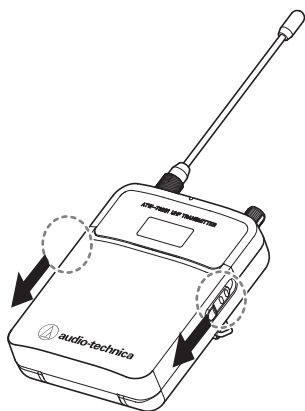

2. Open the battery cover while the latches are slid.

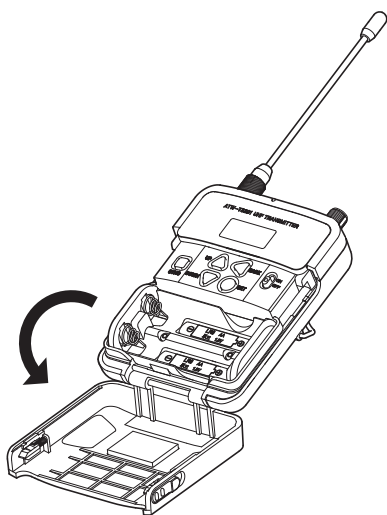

3. Insert the batteries according to the plus (+) and minus (-) marks found inside the battery compartment.

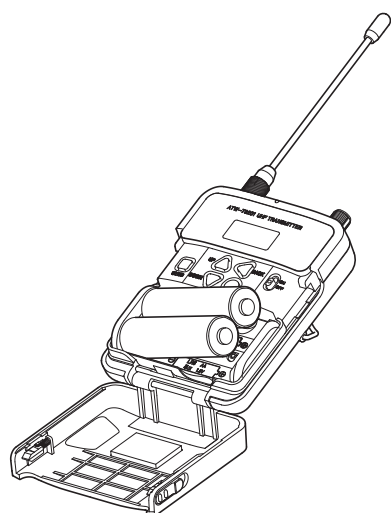

ATW-T3202 / ATW-T3202a

1. Rotate the grip case of the battery compartment.

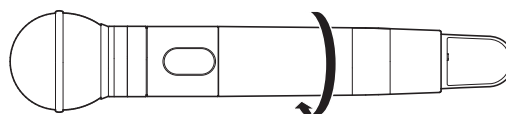

2. Open the battery cover.

- Put your finger on the hook of the battery cover and pull it to open the battery cover.

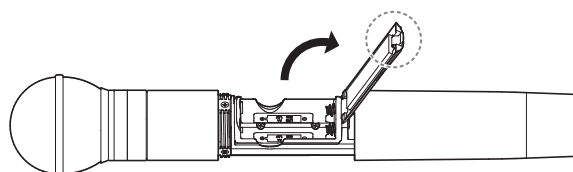

3. Insert the batteries according to the plus (+) and minus (-) marks found inside the battery compartment.

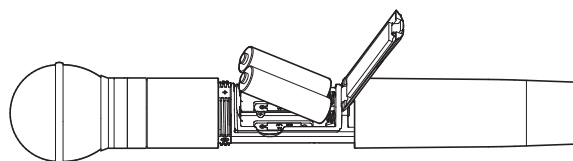

How to attach and detach the interchangeable microphone capsule (only for ATW-T3202 / ATW-T3202a)

How to attach

1. Attach the microphone capsule to the body of the transmitter.

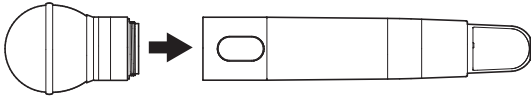

2. Rotate the microphone capsule clockwise to tighten it.

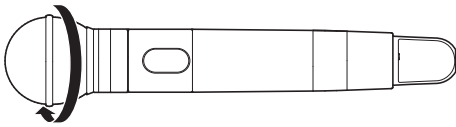

How to remove

1. Rotate the microphone capsule counterclockwise to loosen it.

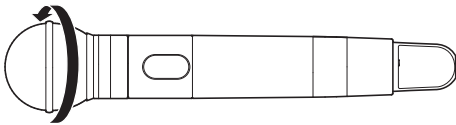

2. Detach the microphone capsule from the body of the transmitter.

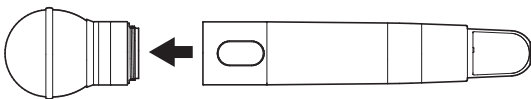

- Do not directly touch or scratch the connection surface.
- Be sure to turn off the power of the transmitter before attaching/detaching the microphone capsule.
- Do not forcibly attach the microphone capsule. Doing so may damage the transmitter or microphone capsule.

How to read the display

ATW-R3210

Main screen

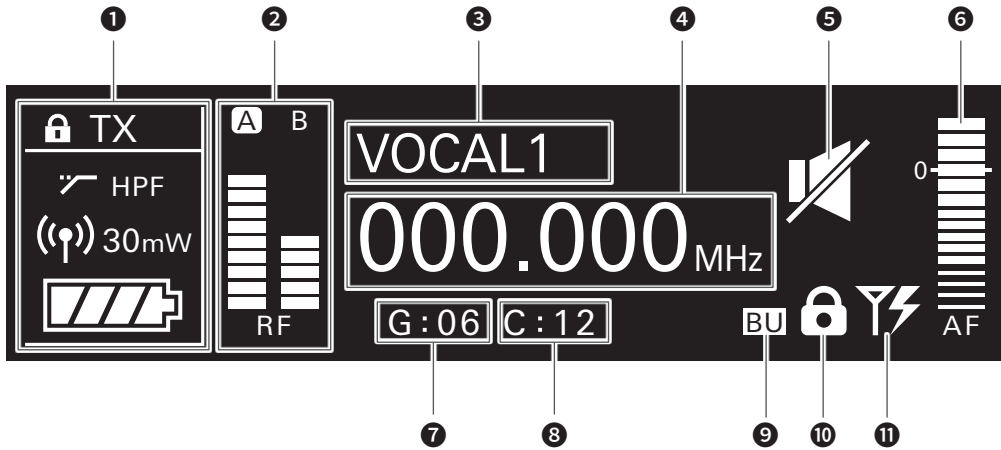

- 1** Transmitter information display area
Information on the connected transmitter is displayed. Refer to "Transmitter information display area" (p. 10) for screen display.
- 2** RF level indicator
Displays the strength of RF reception for antennas A & B.
- 3** Name display
Displays the specified name.
- 4** Frequency indicator
Displays the set frequency.
- 5** Receiver mute indicator
A speaker icon with a slash through it is displayed when the receiver is muted.
- 6** AF level indicator
Displays the strength of the audio signal.
- 7** Group indicator
- 8** Channel indicator
- 9** Backup frequency indicator
"BU" icon is displayed when the backup frequency mode is ON.
- 10** Lock status indicator
- 11** Antenna input power indicator
Icon is displayed when the antenna power supply is ON.

Transmitter information display area

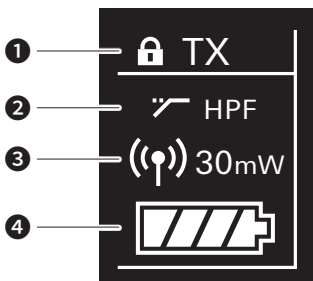

Normal

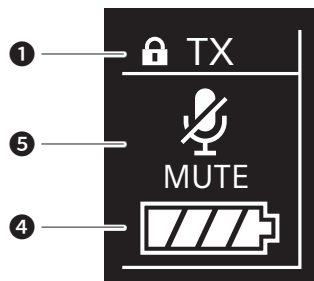

Muted

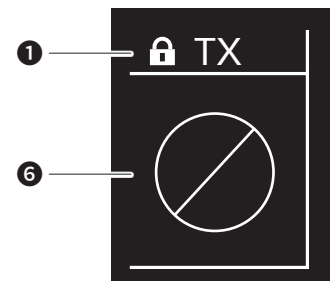

Non-communication

- 1** Lock status indicator
- 2** High-pass filter indicator
- 3** RF power indicator
- 4** Battery level indicator
- 5** Transmitter mute indicator
A microphone with a slash through it is displayed when the transmitter is muted.
- 6** Transmitter non-communication indicator

How to read the display

Level meter screen

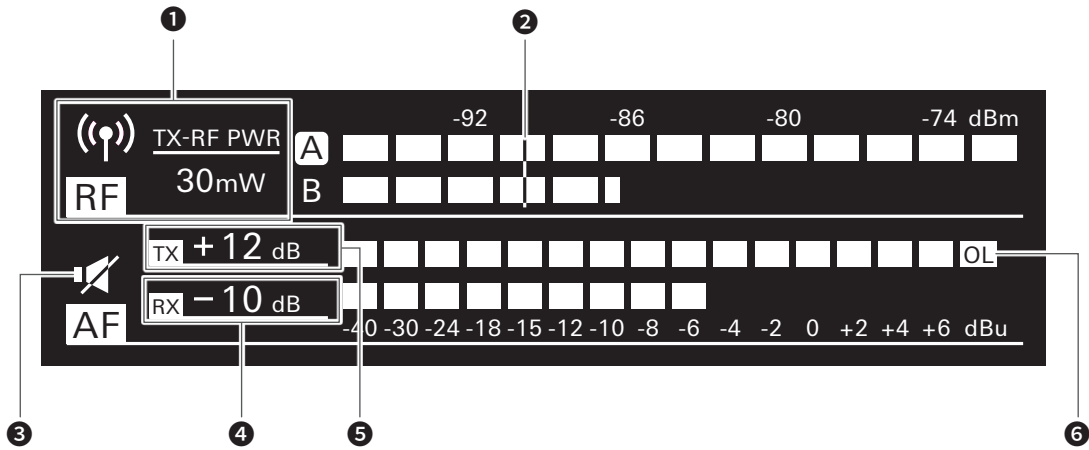

- 1** RF power indicator (transmitter)
- 2** Marker (when the minimum hold function is on)
Shows the minimum level at which the RF is held.
- 3** Mute indicator
A speaker icon with a slash through it is displayed when transmitter is muted.
- 4** Audio output indicator (receiver)
- 5** Gain indicator (transmitter)
- 6** Overload (excessive input) indicator

Minimum hold function

If you press the BACK button on the level meter screen, the minimum hold function turns on and its marker is displayed.

- The marker indicates the lowest level of RF signal received from the transmitter.
- The marker does not move if the input RF level is higher than the marker position.
- If the RF level input is lower than the marker position, the marker moves in tandem with the RF level.
- To reset the marker position, press the BACK button again.

Switching between screens

The screen is switched every time the control dial is rotated right or left.

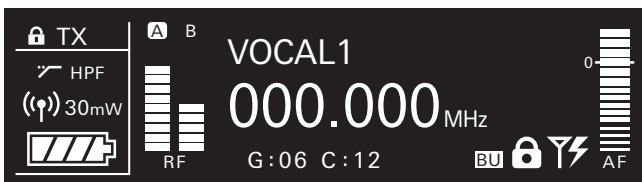

Main screen

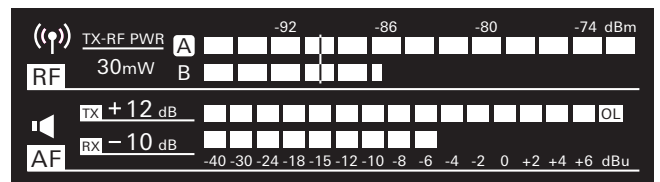

Level meter screen

How to read the display

ATW-T3201 / ATW-T3201a / ATW-T3202 / ATW-T3202a

The main screen is displayed when the power is switched on. If you press the UP/Down button on the main screen, the screen display is switched.

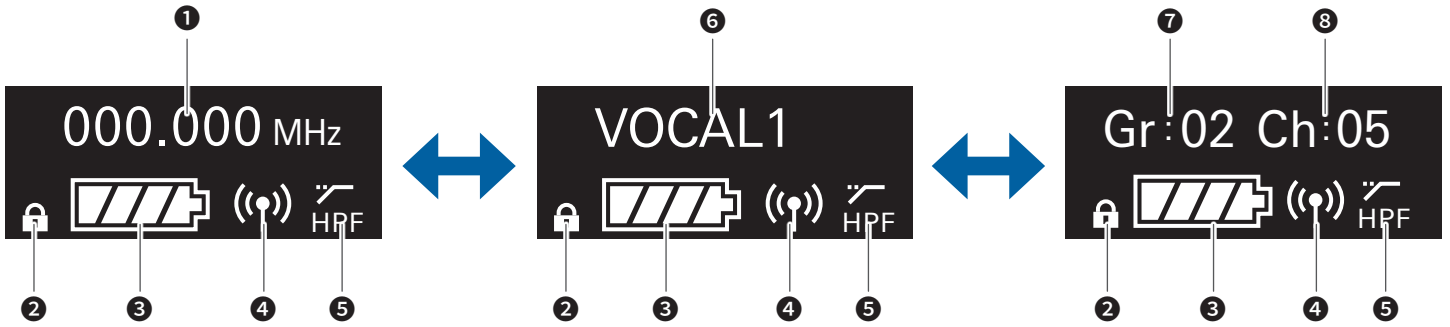





1 Frequency indicator



Displays the set frequency.

2 Lock status indicator

3 Battery level indicator

-  : 75% or more battery power remaining.
-  : 50 to 75% battery power remaining.
-  : 25 to 50% battery power remaining.
-  : 25% or less battery power remaining.
-  (Flicker): Replace the batteries.

4 RF power indicator

-  : RF Power High (30 mW)
-  : RF Power Low (10 mW)
-  : RF Power Off

5 High-pass filter indicator

6 Name display

Displays the specified name.

7 Group indicator

8 Channel indicator

How to operate

Basic operation

1. Turn on the power button of the receiver (ATW-R3210).
 - The display lights and the main screen is displayed.

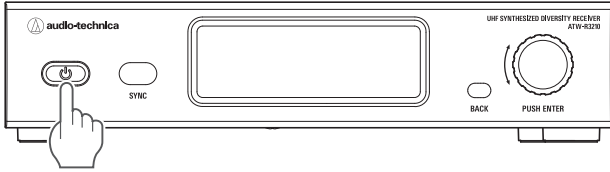

2. Set the operating frequency.
3. Turn on the power switch of the transmitter (ATW-T3201 / ATW-T3201a / ATW-T3202 / ATW-T3202a).
 - The indicator lights and the display shows the main screen.

ATW-T3201 / ATW-T3201a

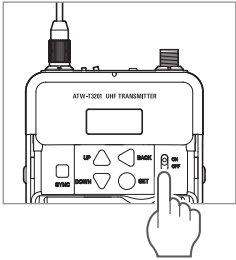

ATW-T3202 / ATW-T3202a

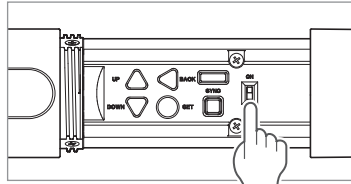

4. Set the transmission frequency.
 5. Check the RF level indicator on the receiver.
 - Check that antenna A or B lights up.
 6. Speak into the microphone.
 - Make sure the AF level indicator lights up on the receiver.
- Hold down the DOWN button of the transmitter while turning on the power switch to start up with the RF output in the OFF state (RF OFF mode).

Using IR SYNC

This function allows you to make settings on the receiver that are specified for the transmitter.

1. When IR SYNC is initiated on the receiver, the “Communication in standby” screen is displayed.
2. Position the IR sync windows of the receiver and transmitter so they face each other.

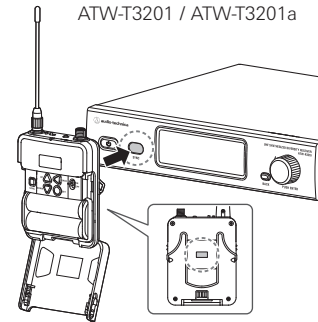

ATW-T3202 / ATW-T3202a

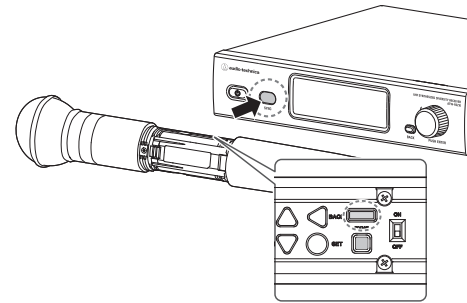

3. Press the SYNC button on the transmitter.
 - Wait several seconds until communication is established.
4. When the SYNC is complete, the “completed” screen is displayed.
 - The settings made on the receiver are automatically synced to the transmitter.
 - If an error occurs in the SYNC process, an error screen opens and then the display returns to the menu screen. Check the IR SYNC windows of the receiver and transmitter and then SYNC again.
 - To cancel the SYNC process, press the BACK button on the receiver. You will be returned to the previous screen.

Using QUICK SYNC

SYNC shortcut allows you to easily move to the settings screen where you can configure the transmitter settings from the receiver.

1. Press and hold the control dial on the main screen for approximately 2 seconds.
2. “TX SYNC” setting screen is displayed.
 - Refer to "Setting transmitters via IR SYNC" p. 16 for subsequent steps.

Settings

Various settings can be made from the menu screen shown on the display.

ATW-R3210

1. Press the control dial.
 - The main menu screen appears.

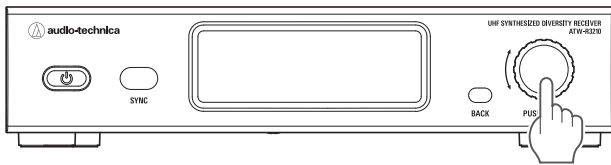

2. Turn the control dial to select the item you wish to set.

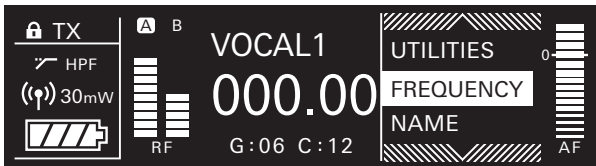

3. Press the control dial to open the settings menu of the selected item.
 - Press the BACK button to go back one screen.
 - To cancel partway through making a setting, press the BACK button.
 - While on the settings screen, the display will return to the main screen if approximately 60 seconds pass without a button or the control dial being used.

ATW-T3201 / ATW-T3201a / ATW-T3202 / ATW-T3202a

1. Press the SET button.
 - The menu screen appears.

ATW-T3201 / ATW-T3201a

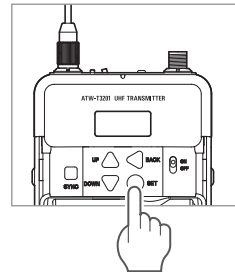

ATW-T3202 / ATW-T3202a

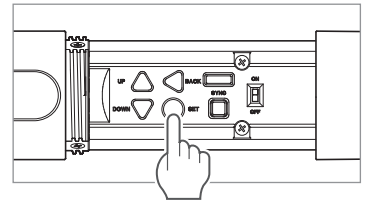

2. Press the UP/DOWN button to select the item you wish to set.

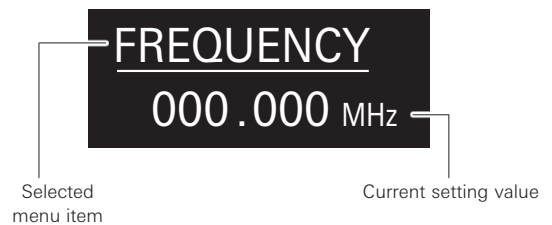

3. Press the SET button to display the settings screen for the selected item.
 - Press the BACK button to go back one screen.
 - To cancel partway through making a setting, press the BACK button.
 - While on the settings screen, the display will return to the main screen if approximately 30 seconds pass without a button being used.

Setting ATW-R3210

List of setting items

FREQUENCY	MANUAL	Set the operating frequency.
	Gr/Ch	
NAME		Set the channel name.
AUDIO		Set the audio output level.
GROUP SCAN		Scan for open channels.
TX SYNC		Set transmitters via IR SYNC.
SQUELCH	AUTO	Set the squelch level.
	MANUAL	
UTILITIES	LOCK	Set this function to prevent the receiver settings from being changed.
	ANT PWR	Set whether to turn power on or off to the antenna input terminals.
	Gr/Ch EDIT	Edit the channel allocation for user groups (U1 and U2).
	BACKUP FREQ	Set the backup frequency.
	DISPLAY	Set the item prominently displayed at the center of the main screen.
	AF METER	Switch the level meter on the main screen between receiver and transmitter.
	BRIGHTNESS	Set the display brightness.
	ACCESS	Set the user access level.
	RESET	This returns the receiver settings to their factory defaults.
	VERSION	This function displays product information such as the version of the receiver.

Setting by group/channel

- From the menu screen, turn the control dial, select [FREQUENCY] and then press the control dial.
- Select [Gr/Ch] and press the control dial.
- Turn the control dial to set the group. When finished setting it, press the control dial.
- Turn the control dial to set the channel. When finished setting it, press the control dial.
 - The setting is complete.

Setting the channel (receiver) name

The following characters can be entered:

- The maximum number of characters that can be entered is 8.

Alphabetic (uppercase letters)	Numeric
Symbols (+, -, #, &, period)	Space

- From the menu screen, turn the control dial, select [NAME] and then press the control dial.
- Turn the control dial, select the desired character and then press the control dial.
 - The character is input and the cursor moves.
- Repeat the operation in Step 2 to enter all characters.
- Turn the control dial, select [End] and then press the control dial.
 - The setting is complete.

Setting the operating frequency

Manual setting

- From the menu screen, turn the control dial, select [FREQUENCY] and then press the control dial.
- Select [MANUAL] and press the control dial.
- Turn the control dial to set the first 3 digits. When finished setting them, press the control dial.
- Turn the control dial to set the last 3 digits. When finished setting them, press the control dial.
 - The setting is complete.

Setting ATW-R3210

Setting the audio output level

1. From the menu screen, turn the control dial, select [AUDIO] and then press the control dial.
2. Turn the control dial to set the audio output level.
 - The level changes 2dB +/- each time you turn the control dial.
 - It can be set from -60 to 0dB.
3. Press the control dial.
 - The setting is complete.

Scanning for open channels

Scan for unused channels in the current environment for use.

1. From the menu screen, turn the control dial, select [GROUP SCAN] and then press the control dial.
2. Turn the control dial to select the group you want to scan. After selecting a group, press the control dial.
3. Turn the control dial to select the preferred threshold. After selecting the threshold, press the control dial.
 - You can select [Normal], [High] or [Low] sensitivity.

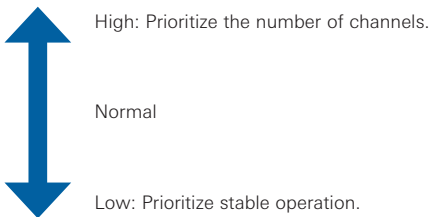

- Scan starts.
4. Confirm the scan result by selecting [OK] and then pressing the control dial.
 - If you want to scan over again, select [Retry].
 5. Available channels and frequencies are shown in a list. Turn the control dial, select an available channel and then press the control dial.
 - The setting is complete.

Setting transmitters via IR SYNC

This function allows you to make transmitter settings on the receiver and then automatically configure the transmitter via IR SYNC. The following are the available settings and setting values:

Settings	Setting values
Freq	Current setting value, NoChange
Name	Current setting value, NoChange
RF Pwr	Low:10mW, High:30mW, NoChange
Gain	-10 to +20dB, NoChange
Lock	Lock, Unlock, NoChange
Batt	Alkaline, Ni-MH, NoChange
HPF	OFF, ON, NoChange

1. From the menu screen, turn the control dial, select [TX SYNC] and then press the control dial.
2. Turn the control dial to select a setting you would like to sync to the transmitter and then press the control dial.
3. Turn the control dial to select the setting value and then press the control dial.
4. Repeat Steps 2 and 3 for each setting you would like to sync to the transmitter.
5. Turn the control dial, select [SYNC START] and then press the control dial.
 - Communication function is in standby.
Refer to "Using IR SYNC" (p. 13) for subsequent steps.

Setting ATW-R3210

Setting the squelch level

Setting automatically

1. From the menu screen, turn the control dial, select [SQUELCH] and then press the control dial.
2. Turn the control dial, select [AUTO] and then press the control dial.
3. Turn the control dial, select [Normal], [High] or [Low] and then press the control dial.
 - You can select one from [Normal], [High] or [Low].

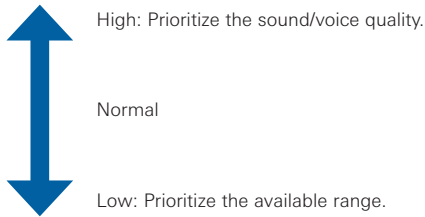

- If an error message is displayed, change the operating frequency. The error indicates that the current frequency is already in use or that there is excessive noise.
 - Scan starts.
4. The scan result is shown. Press the control dial.
 - The setting is complete.

Setting manually

1. From the menu screen, turn the control dial, select [SQUELCH] and then press the control dial.
2. Turn the control dial, select [MANUAL] and then press the control dial.
3. Turn the control dial to select the value you wish to set.
 - The meter indicates the RF level.
 - It can be set from levels 1 to 13.
 - While the available range of the transmitter becomes wider as the squelch level is lower, there may be cases when noises occur under the influence of other radio waves. While the available range of the transmitter becomes narrower as the squelch level is made higher, noises are less likely to occur due to the less influence of other radio waves.
4. Press the control dial.
 - The setting is complete.

Setting the system-related functions

Setting the lock

Set this function to prevent the receiver settings from being changed.

- The default setting is [Unlock].

1. From the menu screen, turn the control dial, select [UTILITIES] and then press the control dial.
2. Turn the control dial, select [LOCK] and then press the control dial.
3. Turn the control dial to select [Lock] or [Unlock], and then press the control dial.
 - The setting is complete.

Setting the antenna power

Set whether to turn power on or off to the antenna input terminals.

- The default setting is [Off].
 - If set to [On], power is supplied to both antennas A and B.
1. From the menu screen, turn the control dial, select [UTILITIES] and then press the control dial.
 2. Turn the control dial, select [ANT PWR] and then press the control dial.
 3. Turn the control dial, select [On] or [Off] and then press the control dial.
 - The setting is complete.

Setting ATW-R3210

Setting user-defined scan groups

Aside from the ten preset groups, there are two additional user-defined scan groups: U1 and U2. Both U1 and U2 can be edited with up to 32 frequencies.

1. From the menu screen, turn the control dial, select [UTILITIES] and then press the control dial.
2. Turn the control dial, select [Gr/Ch EDIT] and then press the control dial.
3. Turn the control dial to select group [U1] or [U2] and then press the control dial.
4. Turn the control dial, select a channel and then press the control dial.
5. Turn the control dial, select [SET] or [RESET] and then press the control dial.
 - By pressing [SET], you can set the frequency of the selected channel.
 - If you press [RESET], the frequency of the selected channel becomes blank.
6. After setting all channels, turn the control dial, select [Sync] or [Save] and then press the control dial.
 - If you press [Save], the setting is completed.
 - If you press [Sync], the screen turns to an IR SYNC standby screen. Execute IR SYNC.

Setting the backup frequency mode

If you set the backup frequency in advance, you can switch the frequency of the transmitter and receiver with the transmitter. It is convenient to set this function when you want to switch the frequency easily.

- The default setting is [Off].
1. From the menu screen, turn the control dial, select [UTILITIES] and then press the control dial.
 2. Turn the control dial, select [BACKUP FREQ] and then press the control dial.
 3. Turn the control dial, select [On] and then press the control dial.
 4. Turn the control dial, select [Manual] or [Gr/Ch] and then press the control dial.
 - If you select [Manual], you can set the frequency.
 - If you select [Gr/Ch], you can set the group/channel.
 5. After setting each item, turn the control dial, select [Set] or [Sync] and then press the control dial.
 - If you press [SET], the setting is completed but you must still sync the setting with the transmitter or set the backup frequency manually on the transmitter in order to use the backup frequency.
 - If you press [Sync], the screen turns to an IR SYNC standby screen. Execute IR SYNC.
 - After [Sync] is complete, the function for the function button switches to [Bkup Freq].

Setting the layout of the main screen

Select the item to be prominently displayed at the center of the main screen.

- The default setting is [Frequency].
1. From the menu screen, turn the control dial, select [UTILITIES] and then press the control dial.
 2. Turn the control dial, select [DISPLAY] and then press the control dial.
 3. Turn the control dial, select [Frequency] or [Name] or [Gr/Ch] and then press the control dial.
 - The setting is complete.

Setting ATW-R3210

Setting the AF level meter on the main screen

Switch the AF level meter on the main screen between [Receiver (Rx)] and [Transmitter (Tx)].

- The default setting is [Rx].
1. From the menu screen, turn the control dial, select [UTILITIES] and then press the control dial.
 2. Turn the control dial, select [AF METER] and then press the control dial.
 3. Turn the control dial, select [Rx] or [Tx] and then press the control dial.
 - The setting is complete.

Setting the display brightness

- The default setting is [High].
1. From the menu screen, turn the control dial, select [UTILITIES] and then press the control dial.
 2. Turn the control dial, select [BRIGHTNESS] and then press the control dial.
 3. Turn the control dial, select [High] or [Low] and then press the control dial.
 - The setting is complete.

Setting the user access level

Set the user access level.

- The default setting is [Free Tuning].
1. From the menu screen, turn the control dial, select [UTILITIES] and then press the control dial.
 2. Turn the control dial, select [ACCESS] and then press the control dial.
 3. Turn the control dial, select [Free Tuning] or [User Group Only] and then press the control dial.

Free Tuning	No limit
User Group Only	Selection of frequency can be made only from user groups (U1 and U2).

- The setting is complete.

Resetting

This returns the receiver settings to their factory defaults.

1. From the menu screen, turn the control dial, select [UTILITIES] and then press the control dial.
2. Turn the control dial, select [RESET] and then press the control dial.
3. Turn the control dial, select [Yes] and then press the control dial.
4. After the confirmation screen is displayed, turn the control dial again to select [Yes] and then press the control dial.
 - Reset starts.

Checking the receiver information

This function displays the receiver information.

1. From the menu screen, turn the control dial, select [UTILITIES] and then press the control dial.
2. Turn the control dial, select [VERSION].

Setting ATW-T3201 / ATW-T3201a / ATW-T3202 / ATW-T3202a

List of setting items

FREQUENCY	MANUAL	Set the transmission frequency.
	Gr/Ch	
NAME		Set the channel name.
GAIN		Set the gain.
RF POWER		Set the transmission output.
HPF		Set HPF (High-Pass Filter).
LOCK		Set a lock.
Fn BUTTON		Set the function allocation for function button.
MUTE MODE (ATW-T3201 / ATW-T3201a only)		Set the mute mode.
UTILITIES	BATTERY	Set the type of batteries used.
	LED	Set whether to constantly keep indicator turned on or off.
	ACCESS	Set the user access level.
	RESET	This returns the transmitter settings to their factory defaults.
	VERSION	It shows the version of the transmitter.

Setting by group/channel

- From the menu screen, press the UP/DOWN button to select [FREQUENCY], and then press the SET button.

FREQUENCY
000.000 MHz

- After selecting [Gr/Ch], press the SET button.

FREQUENCY
Gr/Ch

- Press the UP/DOWN button to set the group. After completing the setting, press the SET button.
- Press the UP/DOWN button to set the channel. After completing the setting, press the SET button.
 - The setting is complete.

Setting the transmission frequency

Setting manually

- From the menu screen, press the UP/DOWN button to select [FREQUENCY], and then press the SET button.

FREQUENCY
000.000 MHz

- After selecting [MANUAL], press the SET button.

FREQUENCY
MANUAL

- Press the UP/DOWN button to set the first 3 digits. After completing the setting, press the SET button.
- Press the UP/DOWN button to set the last 3 digits. After completing the setting, press the SET button.
 - The setting is complete.

Setting the channel (transmitter) name

The following characters can be entered:

- The maximum number of characters that can be entered is 8.

Alphabetic (Uppercase letters)	Numeric
Symbols (+, -, #, &, period)	Space

- From the menu screen, press the UP/DOWN button to select [NAME], and then press the SET button.

NAME

- Press the UP/DOWN to select a desired character and press the SET button.
 - The character is input and the cursor moves.
- Repeat the operation in Step 2 to enter all characters.
 - If you don't enter 8 characters, press the UP/DOWN button and select [End] and then press the SET button.
- After entering the 8th character, press the SET button.
 - [End] is displayed.
- Press the SET button.
 - The setting is complete.

Setting ATW-T3201 / ATW-T3201a / ATW-T3202 / ATW-T3202a

Adjusting the gain

- From the menu screen, press the UP/DOWN button to select [GAIN], and then press the SET button.



- Press the UP/DOWN button to select the gain you wish to set.
 - The level changes 2dB +/- each time you press the UP/DOWN button.
 - It can be set from -10 to +20 dB.
- Press the SET button.
 - The setting is complete.

Setting lock

- From the menu screen, press the UP/DOWN button to select [LOCK], and then press the SET button.



- Press the UP/DOWN button to select [Lock] or [Unlock].

Lock	Locks transmitter buttons
Unlock	Unlocks transmitter buttons

- Press the SET button.
 - The setting is complete.

Setting the RF power

- From the menu screen, press the UP/DOWN button to select [RF POWER], and then press the SET button.



- Press the UP/DOWN button and select [High:30mW], [Low:10mW] or [Off].
- Press the SET button.
 - The setting is complete.

Setting the function for the function button

Select the function to be performed when the function button is pressed.

- From the menu screen, press the UP/DOWN button to select [Fn BUTTON], and then press the SET button.



- Press the UP/DOWN button to select the function you wish to set.

Disable	No function
PushToMute (only for ATW-T3201 / ATW-T3201a)*1*2	Mutes while pressed (even when transmitter buttons are locked)
PushToTalk (only for ATW-T3201 / ATW-T3201a)*1*2	Speaking into the microphone is available while pressed (even when transmitter buttons are locked)
Mute (only for ATW-T3202 / ATW-T3202a)	Presses and hold to mute the transmitter ON/OFF
MuteOnLock (only for ATW-T3202 / ATW-T3202a)	Presses and hold to mute the transmitter ON/OFF (even when transmitter buttons are locked)
QuickMute (only for ATW-T3202 / ATW-T3202a)*2	Presses to mute the transmitter ON/OFF
Bkup Freq	Presses and hold to switch to backup frequency (When selected, set the frequency, group, and channel.)
RF Off	Presses and hold to turn on/off RF power

*1 When this function is selected, the function of the MUTE switch set in mute mode is not available.

*2 When this function is selected, turning the screen back on if it shuts off cannot be used.

Setting HPF (High-Pass Filter)

- From the menu screen, press the UP/DOWN button to select [HPF], and then press the SET button.



- Press the UP/DOWN button to select [On] or [Off].
- Press the SET button.
 - The setting is complete.

- Press the SET button.
 - The setting is complete.

Setting ATW-T3201 / ATW-T3201a / ATW-T3202 / ATW-T3202a

Setting the mute mode (only for ATW-T3201 / ATW-T3201a)

Set the function of the MUTE switch.

- From the menu screen, press the UP/DOWN button to select [MUTE MODE], and then press the SET button.



- Press the UP/DOWN button to select the mode you wish to set.

Mute	Mutes the transmitter
MuteOnLock	Mutes the transmitter (even when transmitter buttons are locked)
Disable	Disables the MUTE switch

- Press the SET button.
 - The setting is complete.

Setting the system-related functions

Setting the battery type

Set the type of batteries used.

- The default setting is [Alkaline].

- From the menu screen, press the UP/DOWN button to select [UTILITIES], and then press the SET button.



- Press the UP/DOWN button to select [BATTERY] and press the SET button.

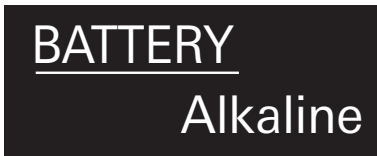

- Press the UP/DOWN button to select the battery you wish to set.

Alkaline	Select when using alkaline batteries.
NiMH	Select when using nickel-metal hydride batteries.

- Press the SET button.
 - The setting is complete.

• If the appropriate setting is not made for the batteries used, the battery power indicator will not display the correct information. Always set the type of battery according to the batteries used.

Setting the indicator

The indicator LED can be turned [On] or [Off].

- The default setting is [On].

- From the menu screen, press the UP/DOWN button to select [UTILITIES], and then press the SET button.



- Press the UP/DOWN button to select [LED] and press the SET button.



- Press the UP/DOWN button to select [On] or [Off].

- Press the SET button.
 - The setting is complete.

Setting the user access level

Set the user access level.

- The default setting is [Free].

- From the menu screen, press the UP/DOWN button to select [UTILITIES], and then press the SET button.



- Press the UP/DOWN button to select [ACCESS] and press the SET button.



- Press the UP/DOWN button to select [Free] or [UserGroup].

Free	No limit
UserGroup	Selection of frequency can be made only from user groups (U1 and U2).

- Press the SET button.
 - The setting is complete.

Setting ATW-T3201 / ATW-T3201a / ATW-T3202 / ATW-T3202a

Resetting

This returns the transmitter settings to their factory defaults.

1. From the menu screen, press the UP/DOWN button to select [UTILITIES], and then press the SET button.



2. Press the UP/DOWN button to select [RESET] and press the SET button.



3. Press the UP/DOWN button to select [Yes].
4. When the confirmation screen is shown, press the UP/DOWN button again to select [Yes].
5. Press the SET button.
 - Reset starts.

Checking the transmitter information

This function displays the firmware version for the transmitter.

1. From the menu screen, press the UP/DOWN button to select [UTILITIES], and then press the SET button.



2. Press the UP/DOWN button to select [VERSION] and press the SET button.
 - The version is shown.



How to attach the transmitter (ATW-T3201 / ATW-T3201a)

The ATW-T3201 / ATW-T3201a transmitter is equipped with a clip that can be used to attach the transmitter to a belt, etc.

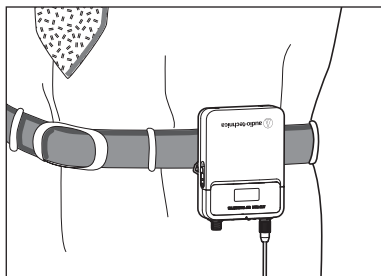

You can reverse the direction of the input connector by attaching the clip in the opposite direction.

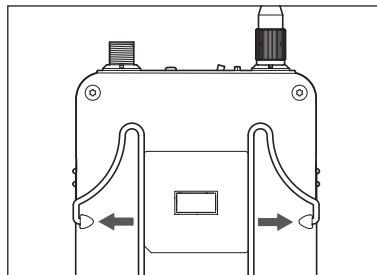

Pull both sides of the clip firmly to the outside to remove the clip from the product.

Making connections (basic connections)

This is an example of connections made when using one receiver.

When connecting more than one receiver via a distributor (sold separately), refer to the distributor's user manual.

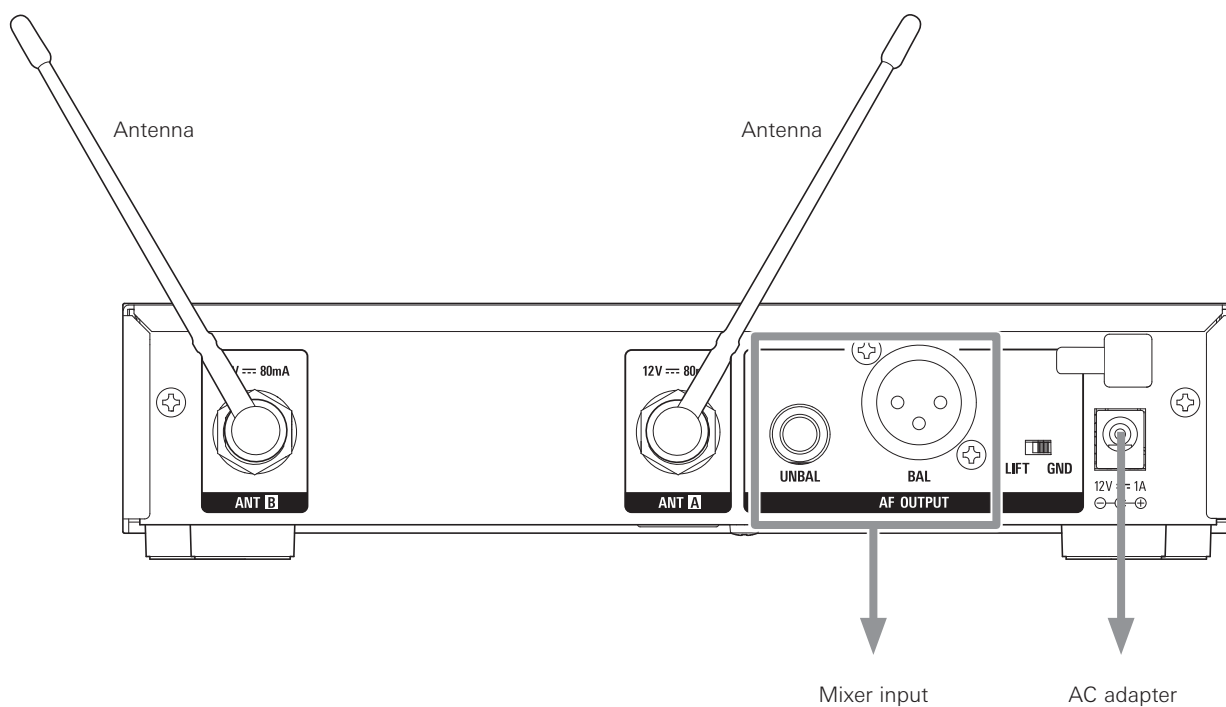

Achieving stable reception

Low RF signal may result if there are obstructions between receiver antennas and transmitter(s). In such a case, reposition the antennas to get better reception. Use external antennas (sold separately) if the installation space is limited.

Rack-mounting the receiver

- Screws for rack-mounting the receiver are not included.
- Consider ventilation when rack-mounting to avoid heat building up in the rack.

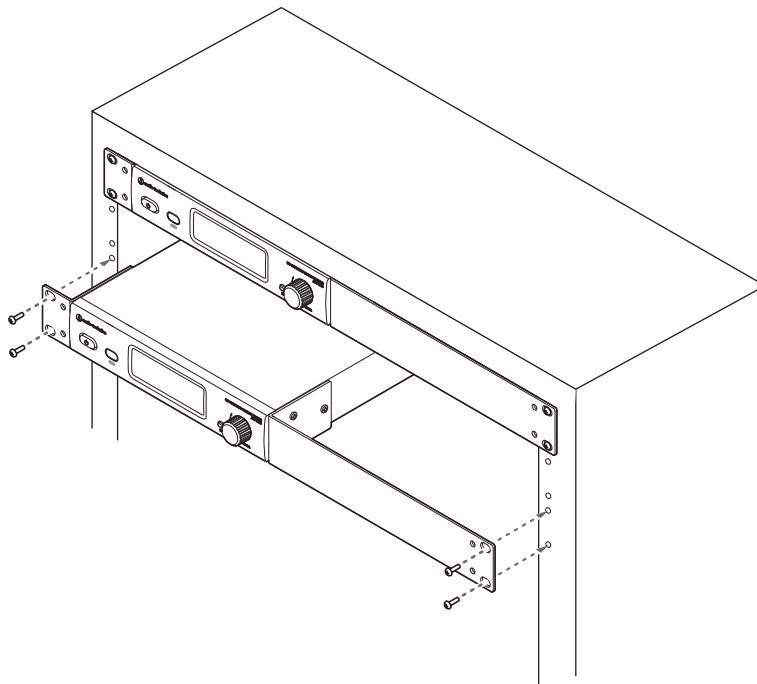

Troubleshooting

ATW-R3210

Symptoms	Causes and countermeasures	Reference page
The power can't be turned on.	Confirm that the AC adapter is correctly connected.	-
There is no voice output. The voice output level is low.	Confirm that the transmitter/receiver channels are correct	p. 15, p. 20
	Confirm that the power button of the receiver is not turned OFF.	p. 13
	Confirm that the antennas are correctly connected.	-
	Confirm that all connected components, such as a mixer, are correctly connected to the receiver.	-
	Confirm that the audio output isn't set to the minimum level.	p. 16
	Confirm that the audio output level of connected components (such as a mixer) is not minimized.	-
Sound is distorted.	Confirm that the audio output level isn't too high.	p. 16
	Confirm that the volume of any connected component isn't too high.	-
There is unwanted noise.	Confirm that there is no noise source, such as a fluorescent lamp or electric component, near the receiver.	-
	Confirm that each transmitter is using a different frequency.	-
	Confirm that the output terminal of the receiver is correctly connected.	p. 24
	Confirm that the receiver isn't taking power from an electrical outlet that is also being used by another noisy component.	-
	Confirm that there isn't any other nearby wireless system using the same frequency band. Adjust the squelch level.	p. 17

ATW-T3201 / ATW-T3201a / ATW-T3202 / ATW-T3202a

Symptoms	Causes and countermeasures	Reference page
The power can't be turned on.	Confirm that batteries are in place.	-
	Confirm that batteries are not depleted.	-
	Confirm that batteries are inserted in the right direction.	p. 8
There is no voice output. The voice output level is low.	Confirm that the transmitter/receiver channels are correct	p. 15, p. 20
	Confirm that the power switch is not turned OFF.	p. 13
	Confirm that RF Power isn't OFF.	p. 21
	Confirm that the transmitter isn't in mute mode.	p. 21
	Confirm that the transmission output of the transmitter is not too low.	p. 21
	Confirm that the microphone or the guitar cable is not disconnected (only for ATW-T3201 / ATW-T3201a).	-
	Confirm that the output volume of the musical instrument, such as a guitar, isn't set at the minimum level.	-
	Confirm that the microphone capsule is connected properly (only for ATW-T3202 / ATW-T3202a).	p. 9
Sound is distorted.	Confirm that the gain setting of the transmitter is not too high.	p. 21
There is unwanted noise.	Confirm that there is no noise source, such as a fluorescent lamp, LED lamp, or electric component, near the transmitter.	-
	Confirm that each transmitter is using a different frequency.	-
	Confirm that the transmission output setting of the transmitter is not too high.	p. 21

Dimensions

ATW-R3210

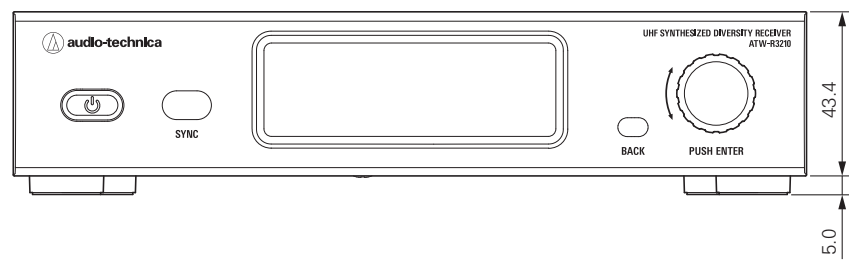
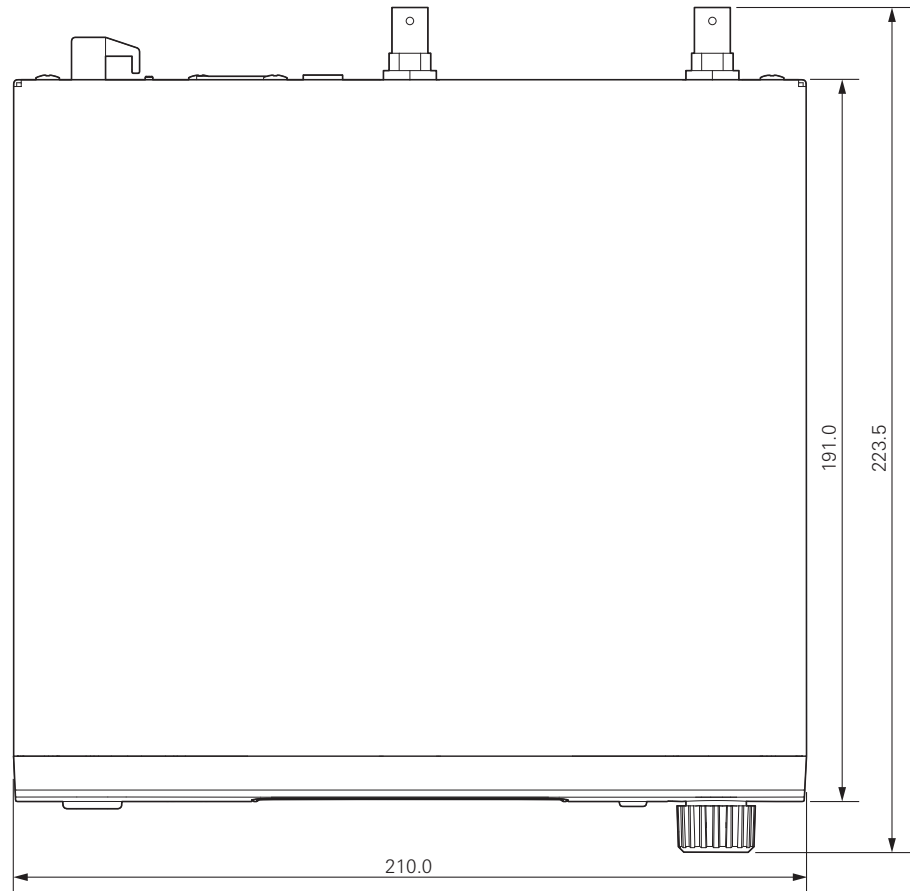
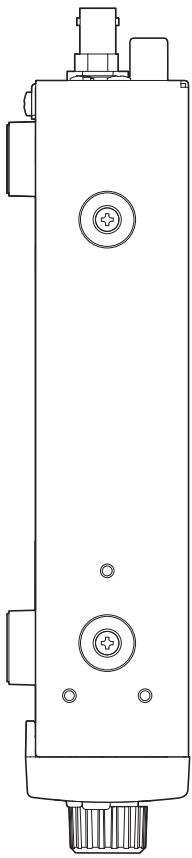
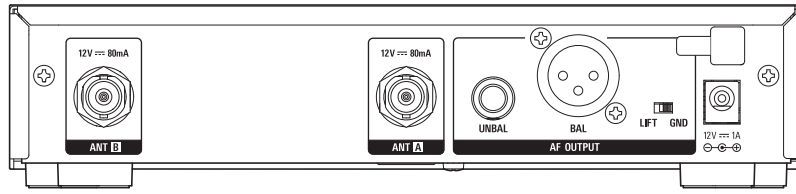

(Unit: mm)

Dimensions

ATW-T3201 / ATW-T3201a

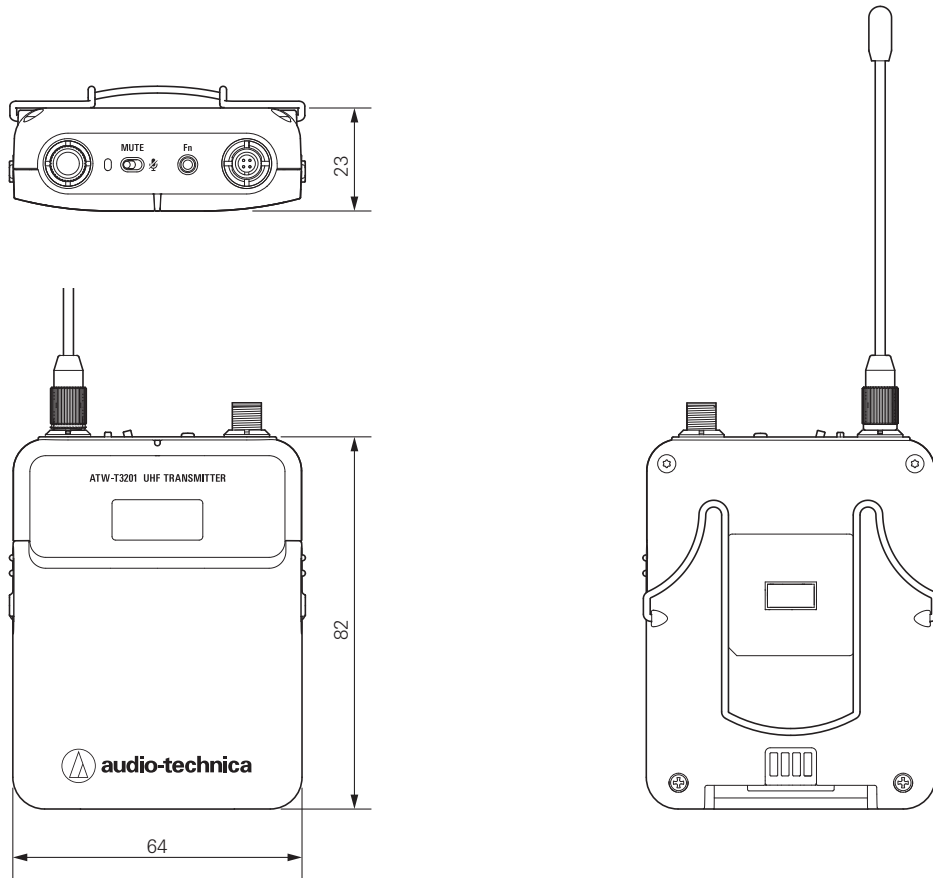

(Unit: mm)

ATW-T3202 / ATW-T3202a

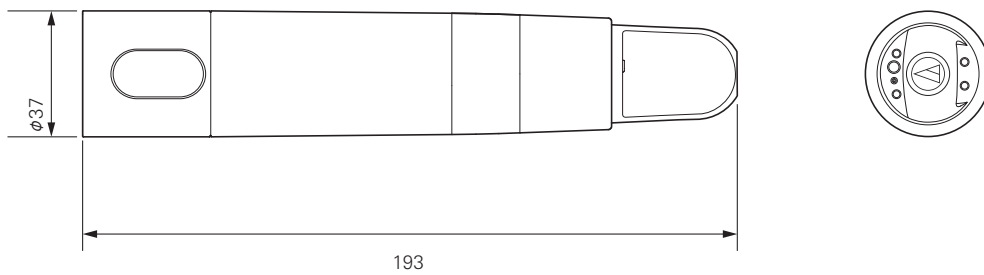

(Unit: mm)

Specifications

Overall system specifications

Operating frequencies*1	Frequency range	Number of frequencies
Band DE2:	470.125 to 529.975 MHz	2,395
Band EE1:	530.000 to 589.975 MHz	2,400
Band EF1:	590.000 to 649.975 MHz	2,400
Band FG1:	650.000 to 699.875 MHz	1,996
Band GG1:	727.100 to 786.900 MHz	2,393
Band GH2:	794.100 to 805.900 MHz	473
Band HH2:	821.100 to 831.900 MHz, 863.100 to 864.900 MHz	506
Band JJ1:	925.100 to 937.400 MHz	493
Minimum frequency step	25 kHz	
Modulation mode	FM	
Maximum deviation	ATW-T3201 / ATW-T3201a: ± 38 kHz (THD:10%) ATW-T3202 / ATW-T3202a: ± 36 kHz (THD:10%)	
Dynamic range	ATW-T3201 / ATW-T3201a Mic input: 115 dB or higher (A-weighted), typical ATW-T3201 / ATW-T3201a Inst input: 112 dB or higher (A-weighted), typical ATW-T3202 / ATW-T3202a: 115 dB or higher (A-weighted), typical	
Total harmonic distortion	1.0 % or less (at 1 kHz, ± 17.5 kHz deviation)	
Operating range*2	100 m (328')	
Frequency response*3	ATW-T3201 / ATW-T3201a: 31 Hz to 15,500 Hz ATW-T3202 / ATW-T3202a: 25 Hz to 16,700 Hz	
Maximum simultaneous use (recommended)*4	40 channels per band*5	

*1 Please note that some frequency bands might not be available in your territory or could come with a limited tuning bandwidth/transmitting power due to local regulations.

*2 Open range environment with no interfering signals.

*3 Frequency response depends on attached microphone element.

*4 For assistance with multi-band operation or other frequency coordination issues, Contact your local audio-technica dealer.

*5 Region and band dependent

ATW-R3210

Receiving system	True diversity
Image rejection	60 dB nominal
RF sensitivity	20 dBuV at 60 dBA S/N ratio (50 ohms termination)
Maximum output level	XLR, Balanced, +14 dBV 6.3 mm (1/4"), Unbalanced, +8 dBV
Antenna input	BNC-type, 50 ohms
Antenna power	12 V DC, 160 mA (combined)
Power supply	100 to 240 V AC (50/60 Hz) to 12V DC 1 A (center positive) switched mode external power supply
Operating temperature range	-5 °C to +45 °C (23 °F to 113 °F)
Dimensions	210.0 mm (8.27") x 191.0 mm (7.52") x 43.4 mm (1.71") (W x D x H)
Weight (without accessories)	1,100 g (38.8 oz)
Included accessories	Rack-mount (large, small), Rack-mount screw set, Flexible UHF antenna x 2, AC adapter (country dependent)

Specifications

ATW-T3201 / ATW-T3201a

RF output power	High: 30 mW, Low: 10 mW (switchable), at 50 ohms	
Spurious emissions	Following federal and national regulations	
Input connection	Four pin locking connector	
	Pin 1: GND	Pin 2: INST INPUT
	Pin 3: MIC INPUT	Pin 4: DC BIAS +5 V
		
High-pass (low-freq. roll-off)	125 Hz, 12 dB/octave	
Batteries	Two 1.5V AA, not included	
Battery life*	High: 8.0 hours (alkaline)	Low: 9.0 hours (alkaline)
	High: 9.0 hours (Ni-MH 1,900 mAh)	Low: 9.5 hours (Ni-MH 1,900 mAh)
Dimensions	64 mm (2.52") x 82 mm (3.22") x 23 mm (0.91") (W x D x H)	
Weight (without batteries)	102 g (3.6 oz)	
Operating temperature range	-5 °C to +45 °C (23 ° F to 113 °F)	

* Depending on battery type, usage and environmental conditions.

ATW-T3202 / ATW-T3202a

RF output power	High: 30 mW, Low: 10 mW (switchable), at 50 ohms	
Spurious emissions	Following federal and national regulations	
Microphone capsule	Interchangeable industry standard thread	
High-pass (low-freq. roll-off)	150 Hz, 6dB/octave	
Batteries	Two 1.5V AA, not included	
Battery life*	High: 8.0 hours (alkaline)	Low: 9.0 hours (alkaline)
	High: 9.0 hours (Ni-MH)	Low: 9.5 hours (Ni-MH)
Dimensions	ATW-T3202 / ATW-T3202a (without capsule): 193 mm (7.60") long, 37 mm (1.46") maximum diameter	
	ATW-T3202/C510, ATW-T3202a/C510: 265 mm (10.43") long, 54 mm (2.13") maximum diameter	
	ATW-T3202/C710, ATW-T3202a/C710: 271 mm (10.67") long, 50 mm (1.97") maximum diameter	
Weight (without batteries)	ATW-T3202 / ATW-T3202a (without capsule): 200 g (7.1 oz)	
	ATW-T3202/C510, ATW-T3202a/C510: 330 g (11.6 oz)	
	ATW-T3202/C710, ATW-T3202a/C710: 314 g (11.1 oz)	
Operating temperature range	-5 °C to +45 °C (23 ° F to 113 °F)	
Included accessories	AT8456a Quiet-Flex™ stand clamp (5/8"-27 male to 3/8"-16 female threaded screw adapter)	

* Depending on battery type, usage and environmental conditions.

For product improvement, the product is subject to modification without notice.

Audio-Technica Corporation

2-46-1 Nishi-naruse, Machida, Tokyo 194-8666, Japan
www.audio-technica.com

©2023 Audio-Technica Corporation

Global Support Contact: www.at-globalsupport.com

232416960-02-03 ver.1 2018.04.15
ver.3 2023.02.15