

The Audio-Technica MCB4 Antenna Combiner allows the signals of up to four M3 Wireless In-Ear Monitor stereo transmitters to be combined onto a single transmitting antenna, reducing rack clutter.

A wide-band unit that operates over the 440-865 MHz range, the MCB4 is designed to complement Audio-Technica M3 Wireless In-Ear Monitor Systems. It is also suitable for many other in-ear wireless systems (with external BNC antenna connections) operating within the 440 to 865 MHz range.



The MCB4 provides one output and four isolated transmitter inputs. All RF connectors are BNC-type.

Four jacks on the rear panel (controlled by the unit's power switch) provide 12V DC (center positive) to power as many as four transmitters operating on 12 volts at up to 600 mA each. Included with the unit

are four DC cables appropriate for use with M3T (or like-powered) transmitters. The 12-volt supplies for powering transmitters are short-circuit protected. The unit features all-metal construction for extreme durability and protection from radio frequency interference.

- Broadband UHF operation (440-865 MHz range)
- Combines the signals of up to four wireless in-ear monitor transmitters into one antenna
- Centralized power supply with ability to power four individual transmitters
- Maintains clean signals with low distortion
- Includes hardware for front-mounting the antenna for improved performance
- Includes adapters to allow the unit to be mounted into a single rack space

### Prior to use of this product, review all safety markings and instructions.

|   |  |  |   |
|---|--|--|---|
|  | <p><b>CAUTION</b><br/>RISK OF ELECTRIC<br/>SHOCK<br/>DO NOT OPEN</p> | <p><b>AVIS</b><br/>RISQUE DE CHOC<br/>ÉLECTRIQUE<br/>NE PAS OUVRIR</p> |  |
|---|--|--|---|

To prevent electric shock, do not remove the cover. There are no user-serviceable parts inside. Internal adjustments are for qualified professionals only. Refer all servicing to qualified service personnel.

Pour prévenir un choc électrique, ne pas ouvrir le couvercle. Il n'y a aucune pièces de rechanges à l'intérieur. Tout ajustement interne doit être fait par une personne qualifié seulement. Référez tout réparation au personnel qualifié.

**WARNING: This apparatus must be grounded.**  
This product is a safety class 1 product. There must be an uninterruptible safety earth ground from the main power source to the product's AC input. Whenever it is likely that the protection has been impaired, disconnect the power cord until the ground has been restored.

**ATTENTION: Cet appareil doit être mise à la terre.**  
Cet appareil est de classe de sûreté 1. Il doit y avoir un ininterrompable de mise à la terre de sécurité provenant de la source principale de courant de l'appareil de l'entrée du courant alternatif. Quand la protection a été affaiblie, débrancher le fil de courant jusqu'à la mise à terre a bien été réétablie.

|   |  |
|---|--|
|  | <p><b>Warning/Attention:</b><br/>To prevent fire or shock hazard, do not expose this appliance to rain or moisture.<br/>Pour prévenir feu ou choc électrique, ne pas exposé l'appareil à la pluie ou à l'humidité.</p> |
|---|--|

The detachable IEC type power input cord supplied is intended for use in regions with mains voltage in the range of 100–125VAC only. Use only the furnished power cord that includes the appropriate NEMA 5-15P/ANSI C73.11 type attachment plug.

For use in geographical areas with mains voltage outside of the range 100–125VAC, it is necessary for the user to utilize a power cord rated and configured for operation in their region. Replace the supplied power cord with a cord rated for correct voltage operation.

Fig. A—Connections

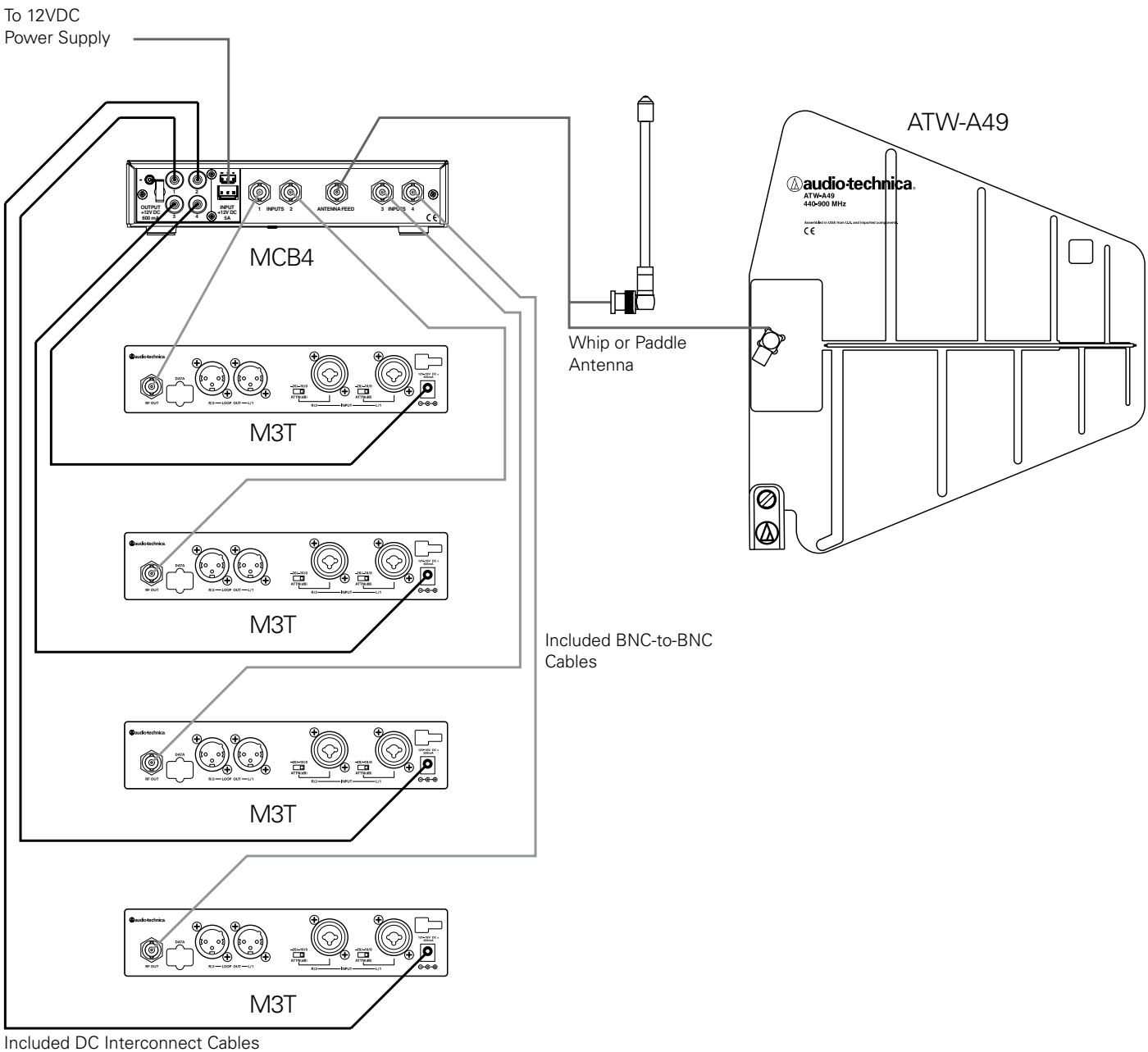

1. Use the included BNC-to-BNC cables to connect the RF OUT of each M3T Transmitter to the INPUTS of the MCB4 Antenna Combiner.
2. Attach the antenna (one included with each M3T Transmitter), or an optional ATW-A49S directional antenna, to the ANTENNA FEED connector on the MCB4 Antenna Combiner.
3. If desired, connect the MCB4 DC OUTPUT to the DC INPUT of each M3T transmitter.
4. Plug the included desktop power supply of the MCB4 into the DC power input. The power supply is designed to operate properly from any AC power source 100-240V, 50/60 Hz without user adjustment. Simply connect the power supply to a standard AC power outlet.

**Fig. B—Front Panel Controls**

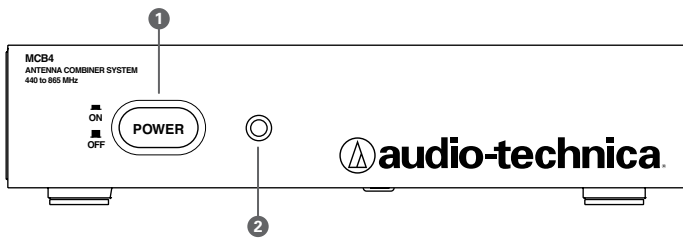

1. POWER SWITCH: Press switch to apply power to unit. Press again to turn unit off.
2. POWER INDICATOR: The indicator will light when power is applied.

**Fig. C—Rear Panel Controls**

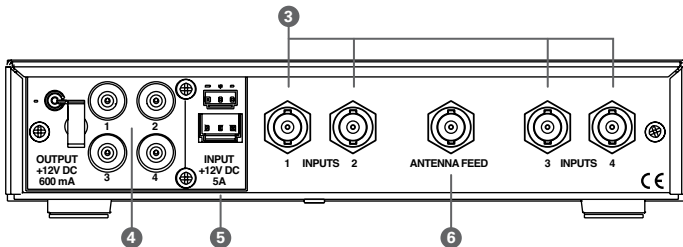

3. INPUTS 1 - 4: BNC isolated transmitter antenna inputs. Maximum RF input is +20 dBm or 100mW.
4. DC OUTPUT JACKS: Provides +12V DC (center positive) at up to 600 mA from each jack to power M3T transmitters.
5. DC POWER INPUT: 3-pin header connector for +12V DC power input.
6. ANTENNA FEED: Attachment point for a standard 50 ohm antenna.

**Fig. D—Front-mount Antenna—Rack Mount Hardware Kit**

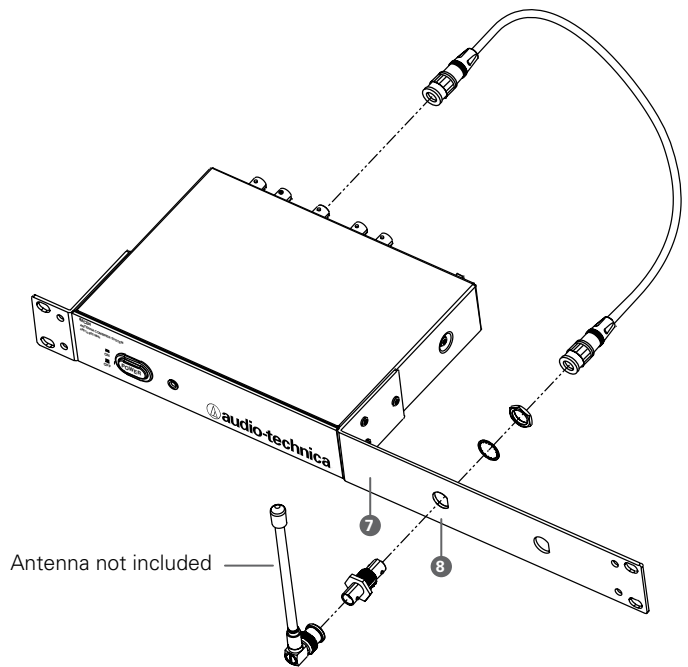

7. The included rack-mount hardware kit (includes rack ears and hardware) is provided to permit attachment in a standard 19" audio equipment rack.
8. The antenna may be mounted on the front of the long rack ear. The following parts are included in the kit: Long rack ear; short rack ear; one BNC bulkhead connector with mounting hardware; one 34" BNC-to-BNC cable; six rack-mount screws.

**Assembling the Rack Mount Hardware Kit**

- Remove the nut and lock-washer from the bulkhead connector. Install the connector *from the front* into one of the two holes in the long rack ear (see **Fig. D**). Note that the flat on the threaded section must be aligned with the flat in the panel hole.
- Install the lock-washer and nut (included) over the back of the bulkhead connector. Secure the connector from the back with its lock-washer and nut, tightening the nut firmly.
- Connect one end of the provided BNC-BNC cable to the antenna feed input jack on the back of the MCB4. Attach the other end of the cable to the back of the BNC bulkhead connector. Make certain the bayonet twist-ring is *fully* latched on the connector at both ends.
- Finally, mount the transmitter antenna to the BNC bulkhead connector.

**Note:** To mount two MCB4 units side by side in a single rack space, use Audio-Technica AT8630 Joining-plate Kit.

**Specifications†**

|                                |  |
|--------------------------------|--|
| Description                    | 4-Way Active Combiner  |
| Bandwidth                      | 440–865 MHz  |
| VSWR                           | < 1.7:1 (within specified bandwidth)   |
| System Gain (per channel)      | 0dB Typical<br>(within specified bandwidth)  |
| Impedance                      | 50 ohms, typical (within specified bandwidth)  |
| Termination Type               | BNC Female (5 total)   |
| Maximum RF Input Power         | +20 dBm or 100 mW  |
| Third Order Intercept Point    | Greater than 25 dBm  |
| Weight                         | 1.0 kg (2.2 lbs.)  |
| Dimensions<br>(Base unit only) | 210 mm (8.27") W x 176 mm<br>(6.93") D x 46 mm (1.80") H<br>(one rack space)   |
| Power Supply                   | Desktop Switching Power Supply<br>Rated at 5A @ 12VDC or 60 Watts<br>Input Voltage 100-240VAC via<br>detachable IEC 320/C14 cable<br>Output is provided on an<br>overmolded 3-pin Molex style<br>termination |
| Accessories                    | IEC 320/C14 power cable (for<br>power supply); 5 - 22" RF (BNC to<br>BNC) cables; 4 – DC power cables;<br>Rack kit for front-mounting<br>antennas and adaptation to a<br>19" rack                            |
| Transmitter power (optional)   | 600mA @ 12VDC – 4 outputs  |

† Specifications are subject to change without notice.

**U.S. Two-Year Limited Warranty**

This product and selected Audio-Technica brand products purchased in the U.S.A. from an authorized Audio-Technica (A.T.U.S.) dealer are warranted for two years from date of purchase by A.T.U.S. to be free of defects in materials and workmanship. To identify those products, go to [www.audio-technica.com/usawarranties](http://www.audio-technica.com/usawarranties). In event of a defect, End-User's exclusive remedy is at A.T.U.S.' election, the cost of repair, refund of the purchase price in the form of credit or cash, or replacement of the product. The product must be delivered to A.T.U.S. or an Authorized Service Center, prepaid, together with the sales slip or other proof of purchase date. This warranty excludes defects due to normal wear, abuse, shipping damage, or failure to use product in accordance with instructions. This warranty is void in the event of unauthorized repair or modification, or removal or defacing of the product labeling.

For U.S. service return instructions and procedure please go to: [www.audio-technica.com/returninstructions](http://www.audio-technica.com/returninstructions).

A.T.U.S.' warranty is to the End User only. Except for A.T.U.S.' said express warranty, A.T.U.S. MAKES NO WARRANTIES, EXPRESS OR IMPLIED, WITH RESPECT TO THE PRODUCTS. A.T.U.S. SPECIFICALLY MAKES NO WARRANTY OF MERCHANTABILITY OR FITNESS FOR A PARTICULAR PURPOSE.

Except to the extent precluded by applicable state law, A.T.U.S. IS NOT LIABLE FOR CONSEQUENTIAL, INCIDENTAL, DIRECT OR SPECIAL DAMAGES ARISING, DIRECTLY OR INDIRECTLY, IN RESPECT OF SUCH PRODUCTS OR USE OR FAILURE THEREOF, WHETHER BASED ON BREACH OF WARRANTY, NEGLIGENCE, STRICT LIABILITY, TORT OR OTHERWISE.

This warranty gives you specific legal rights, and you may have other rights which vary from state to state.

Outside the U.S.A., please contact your local dealer for warranty details.

Audio-Technica U.S., Inc.  
1221 Commerce Drive  
Stow, Ohio 44224

To reduce the environmental impact of a multi-language printed document, product information is available online at [www.audio-technica.com](http://www.audio-technica.com) in a selection of languages.

Afin de réduire l'impact sur l'environnement de l'impression de plusieurs, les informations concernant les produits sont disponibles sur le site [www.audio-technica.com](http://www.audio-technica.com) dans une large sélection de langue.

Para reducir el impacto al medioambiente, y reducir la producción de documentos en varios leguajes, información de nuestros productos están disponibles en nuestra página del Internet: [www.audio-technica.com](http://www.audio-technica.com).

Para reduzir o impacto ecológico de um documento impresso de várias línguas, a Audio-Technica providência as informações dos seus produtos em diversas línguas na [www.audio-technica.com](http://www.audio-technica.com).

Per evitare l'impatto ambientale che la stampa di questo documento determinerebbe, le informazioni sui prodotti sono disponibili online in diverse lingue sul sito [www.audio-technica.com](http://www.audio-technica.com).

Der Umwelt zuliebe finden Sie die Produktinformationen in deutscher Sprache und weiteren Sprachen auf unserer Homepage: [www.audio-technica.com](http://www.audio-technica.com).

Om de gevolgen van een gedrukte meertalige handleiding op het milieu te verkleinen, is productinformatie in verschillende talen "on-line" beschikbaar op: [www.audio-technica.com](http://www.audio-technica.com).

本公司基於環保理由將減少多語言文件印刷，陸續產品訊息可在 [www.audio-technica.com](http://www.audio-technica.com) 的官方網頁上選擇語言與瀏覽。

本公司基于环保理由将减少多语言文件印刷，陆续产品信息可在 [www.audio-technica.com](http://www.audio-technica.com) 的官方网页上选择语言与浏览。

자원절약, 환경보호를 위해 국문 사용 설명서는 인쇄하지 않았습니다. 제품정보는 [www.audio-technica.com](http://www.audio-technica.com) 에서 원하는 언어 선택 후에 다운로드 받으실 수 있습니다.



Audio-Technica U.S., Inc.  
1221 Commerce Drive, Stow, Ohio 44224 USA +1 (330) 686-2600  
Audio-Technica Limited  
Old Lane, Leeds LS11 8AG England +44 (0) 113 277 1441  
Audio-Technica (Greater China) Limited  
Unit K, 9/F, Kaiser Est. (Ph.2) 51 Man Yue St. Kowloon, HK. +852-2356-9268  
Audio-Technica (S.E.A.) Pte. Ltd.  
No 1 Ubi View, #01-14 Focus One, Singapore 408555 +65-6749-5686  
Audio-Technica Corporation  
2206, Naruse Machida, Tokyo Japan