



ES964

Boundary Microphone Array

User Manual

English

Safety precautions

Although this product was designed to be used safely, failing to use it correctly may result in an accident. To ensure safety, observe all warnings and cautions while using the product.

Cautions for the product

- Do not subject the product to strong impact to avoid malfunction.
- Do not disassemble, modify or attempt to repair the product.
- Do not handle the product with wet hands to avoid electric shock or injury.
- Do not store the product under direct sunlight, near heating devices or in a hot, humid or dusty place.
- Do not place the product on an unstable surface to avoid injury or malfunction due to falling or the like.

Notes on use

- Do not swing the microphone by holding the cable or pull on the cable forcefully. Doing so may cause disconnection or damage.
- Do not install near air conditioners or lighting fixtures, as doing so may cause malfunction.
- Do not wind the cable around the rack or allow the cable to become pinched.
- Install the microphone on a flat, unobstructed mounting surface. Make sure that the sound source is not below the mounting surface.
- Placing any object on a surface (such as a conference table) before its finish is fully cured may result in damage to the finish.

Package contents

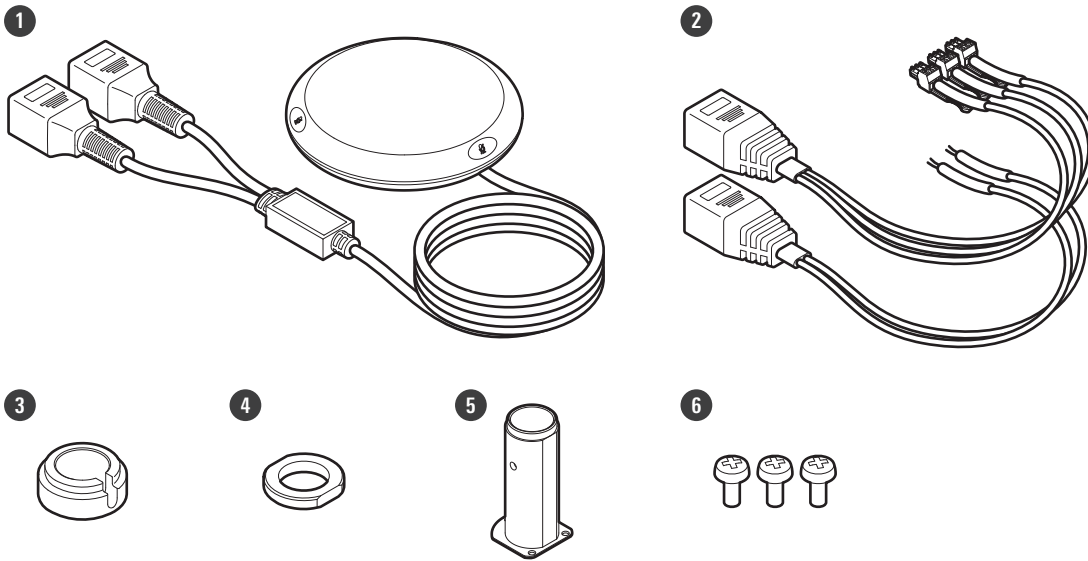

- 1** Microphone
- 2** RJ45 breakout cable x 2
- 3** Rubber isolator
- 4** Fixing nut
- 5** Table mount adapter
- 6** Table mount adapter mounting screw x 3

Part names and functions

Top

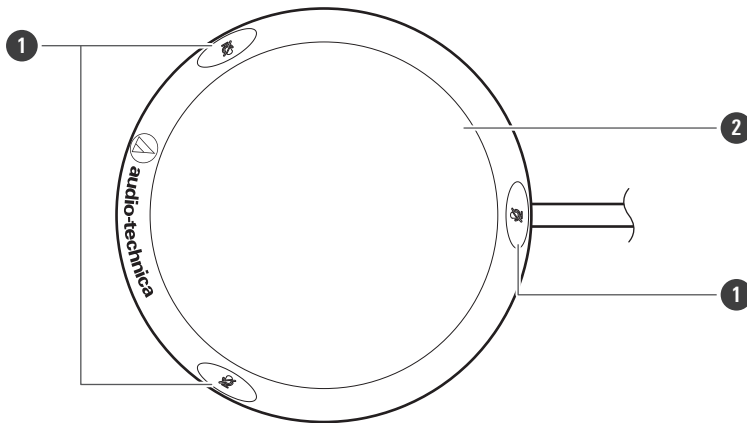

1 Talk switches

Switches between mute and unmute.

2 Microphone body

Side

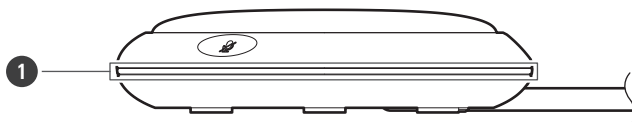

1 Talk indicator lamp

Indicates the mute/unmute status by the color of indicator lamp that lights.

Bottom

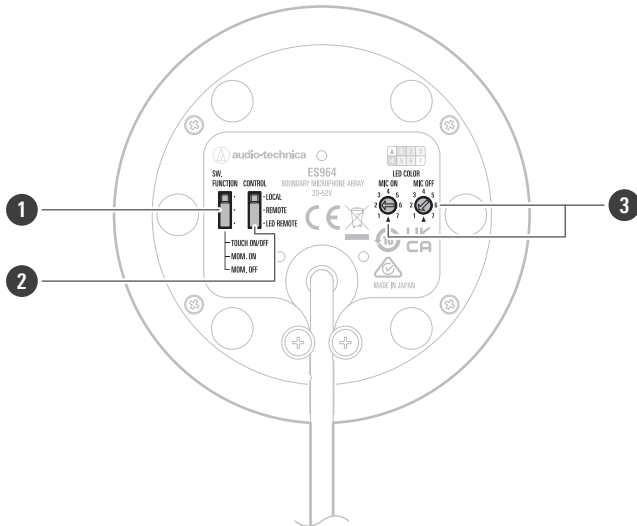

1 SW. FUNCTION

Sets how the talk switches operate.

Mode	Operation method
TOUCH ON/OFF	Each time you touch a talk switch, the microphone is turned on or off.
MOM. ON	The microphone is turned on as long as you are touching a talk switch. The microphone is turned off when you stop touching the talk switch.
MOM. OFF	The microphone is turned off as long as you are touching a talk switch. The microphone is turned on when you stop touching the talk switch.

2 CONTROL

Sets whether the microphone is muted/unmuted and whether the talk indicator lamp is lit by using the product or the external control device.

Mode	Operation
LOCAL	The microphone is muted/unmuted using a talk switch on the product. The talk indicator lamp also lights in conjunction with talk switch operation.
REMOTE	The microphone always stays on. The talk indicator lamp lights in conjunction with the operation of the talk switches, and the operation information is transmitted to the external control device via the CLOSURE terminal. The external control device controls muting/unmuting.
LED REMOTE	The microphone always stays on, and the external control device controls muting/unmuting and lights the talk indicator lamp. Talk switch operation information is transmitted to the external control device via the CLOSURE terminal.

Part names and functions

3 LED COLOR

You can select the color in which the talk indicator lamp lights when muted/unmuted.

Connection procedure

1 Connect the output terminals (RJ45 jacks) on the microphone cable to the included RJ45 breakout cables by using commercially available STP cables.

- Connect microphone output terminals A and B to RJ45 breakout cables A and B, respectively.

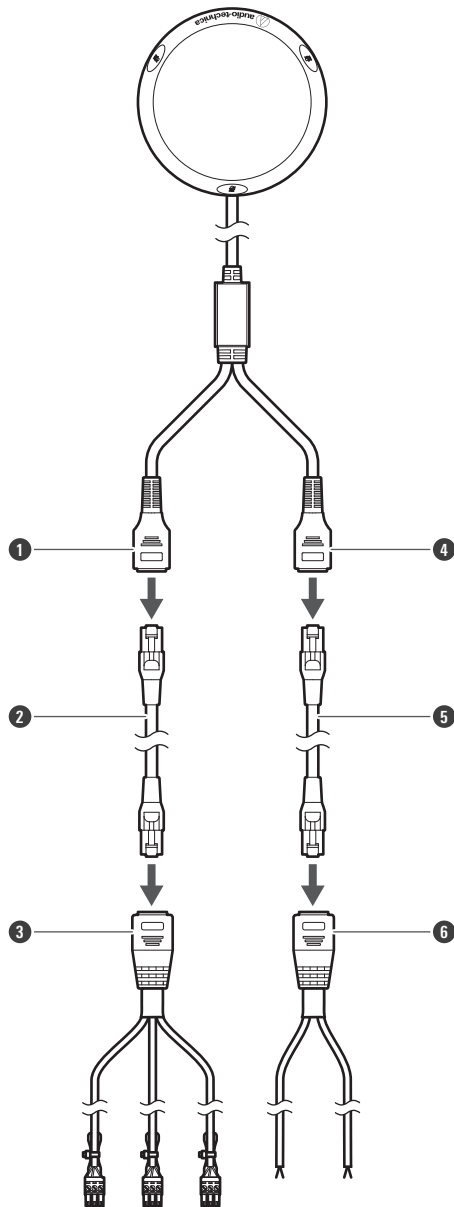

- 1 Microphone output terminal A
- 2 Commercially available STP cable (MIC 1 to MIC 3)
- 3 RJ45 breakout cable A
- 4 Microphone output terminal B
- 5 Commercially available STP cable (LED control / CLOSURE control)
- 6 RJ45 breakout cable B

Connection procedure

- 2** Connect the output terminals on the RJ45 breakout cables to a device that has a microphone input (balanced input) that is compatible with a phantom power supply.

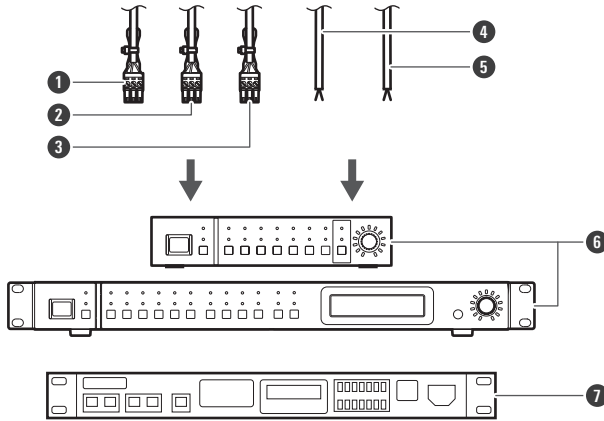

- ① MIC 1
- ② MIC 2
- ③ MIC 3
- ④ LED control
- ⑤ CLOSURE control
- ⑥ ATDM series DIGITAL SMARTMIXER™
- ⑦ Third-party mixer

- The product requires 20 to 52 V DC phantom power supply for operation.
- The output connectors are Euroblock connectors with polarity as shown in the "Wiring table" (p. 8).

Wiring table

- Microphone output is low impedance (Lo-Z), balanced type. Signals are output on each pair of Euroblock connectors on the RJ45 breakout cables. Audio grounding is achieved with a shielded connection. The output of each Euroblock connector is as shown in the pin assignment.
- MIC 1 is "O" (omnidirectional) and MIC 2 is "L" (bidirectional), with both positioned at 240° horizontally. MIC 3 is "R" (bidirectional), and is positioned at 120° horizontally. These are combined to create a directional pattern in any desired direction.
- The pin number sequence of the output terminals is as follows.

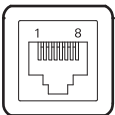

OUT A

The pin numbers and functions of the RJ45 connectors and the colors of the RJ45 breakout cables are as follows.

Connection procedure

Pin No. / Function	Cable color
PIN 1 / MIC 2 L (+)	Brown
PIN 2 / MIC 2 L (-)	Orange
PIN 3 / MIC 3 R (+)	Green
PIN 4 / MIC 1 O (-)	White
PIN 5 / MIC 1 O (+)	Red
PIN 6 / MIC 3 R (-)	Blue
PIN 7 / GND	Black
PIN 8 / GND	Black

OUT B

The pin numbers and functions of the RJ45 connectors and the colors of the RJ45 breakout cables are as follows.

Pin No. / Function	Cable color
PIN 1 / Blank	-
PIN 2 / Blank	-
PIN 3 / LED	Green
PIN 4 / Blank	-
PIN 5 / CLOSURE	Red
PIN 6 / Blank	-
PIN 7 / GND	Black
PIN 8 / GND	Black

Pin assignment

MIC 1

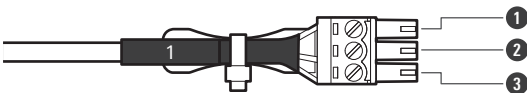

- ① O+
- ② O-
- ③ GND

Connection procedure

MIC 2

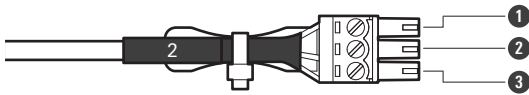

- ① L+
- ② L-
- ③ GND

MIC 3

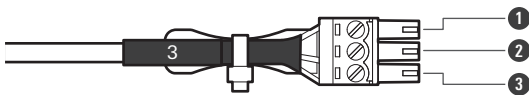

- ① R+
- ② R-
- ③ GND

LED control



- ① GND
- ② LED (green)

CLOSURE control



- ① GND
- ② CLOSURE (red)

Installation procedure

How to mount the product

The product is mounted by drilling a hole in a table and using the included table mount adapter to secure it to the table.

1 Decide where you want to mount the product and drill a hole in the table at that location.

- A 30 mm (1.2") diameter hole is required. Also, the maximum thickness of the table is 30 mm (1.2").

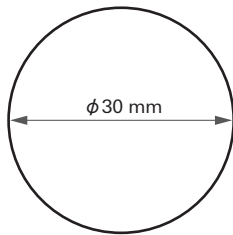

2 Remove the cable fixing screws on the bottom of the microphone.

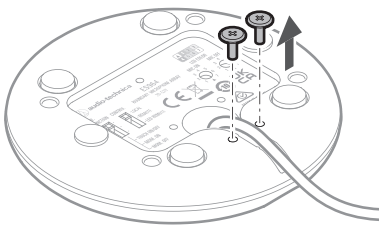

- Retain and do not lose the removed cable fixing screws. You will need them if you ever decide to use the product without attaching it to a table.

3 Attach the table mount adapter to the bottom of the microphone.

- Attach the table mount adapter with the included table mount adapter mounting screws.
- Attach the table mount adapter so that the cable runs alongside the table mount adapter. Do not pass the cable through the interior of the table mount adapter.

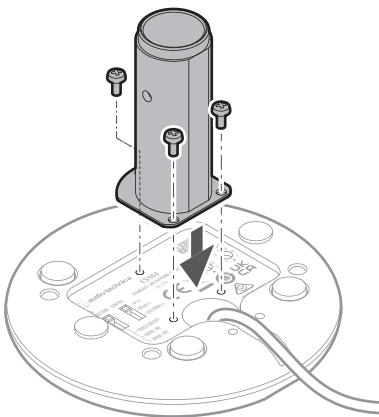

Installation procedure

- 4** Pass the end of the cable down through the hole in the table and then pass the table mount adapter through the hole. Next, pass the rubber isolator up around the table mount adapter and insert it into the hole in the table, making sure that the cable runs along the indentation on the rubber isolator.

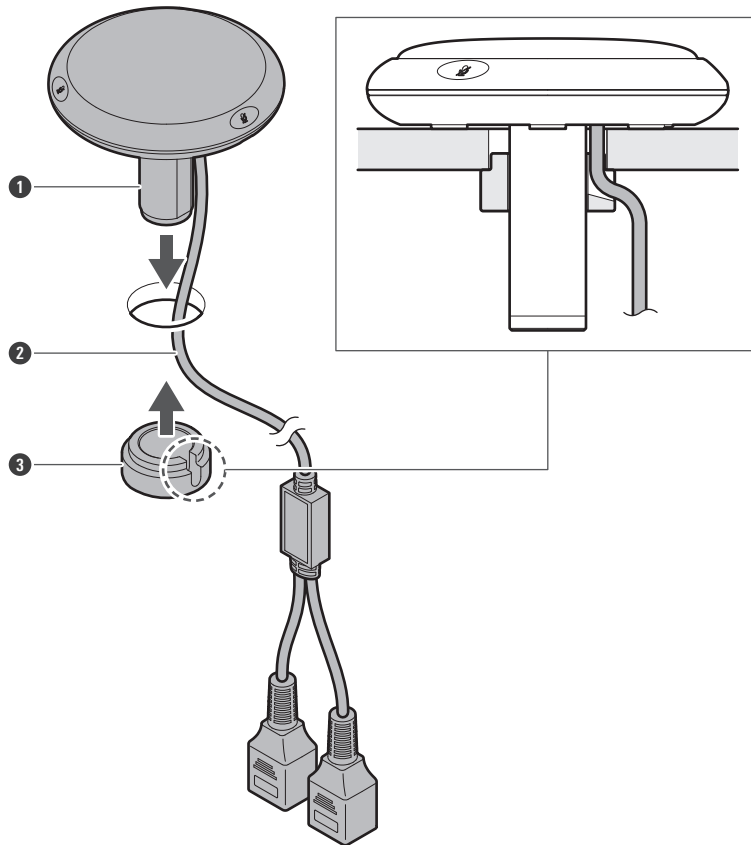

- ① Table mount adapter
- ② Cable
- ③ Rubber isolator

- 5** Adjust the orientation of the microphone.

- Adjust the orientation of the microphone so that the Audio-Technica logo faces forward when in use.

- 6** Tighten the fixing nut to secure the microphone.

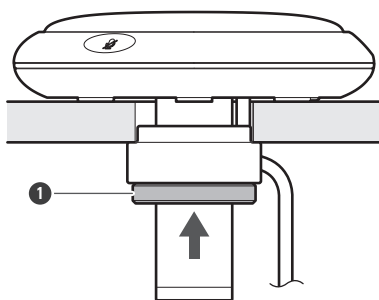

Installation procedure

1 Fixing nut

Mounting without using the table mount adapter

When mounted and installed without using the table mount adapter and without drilling a 30 mm (1.2") diameter hole in the table, the microphone is secured using the two screw holes shown in the figure below.

- Remove the cable fixing screws on the bottom of the microphone and use commercially available screws. Screw size should be M3 P=0.5 and screw length should be no more than 7 mm (0.28") from the bottom of the head to the tip of the screw.

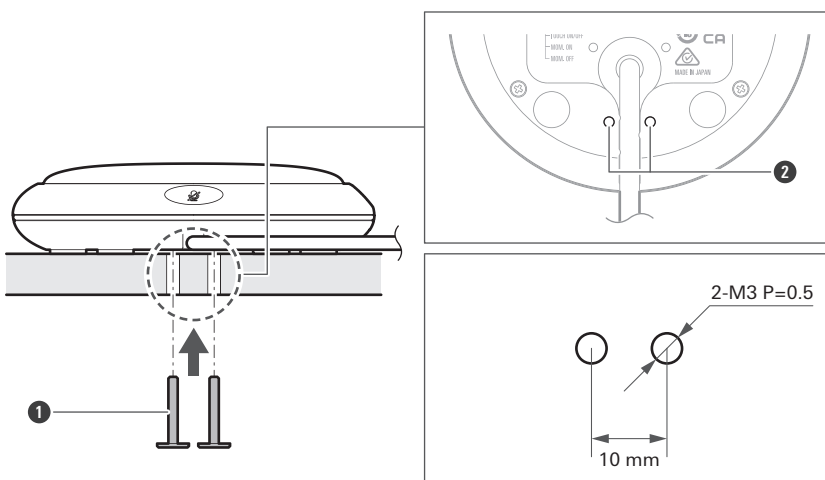

1 Screws (commercially available)

2 Screw holes

Sound pickup coverage

For 360° coverage

Creates four hypercardioid (Normal) virtual directional patterns at 0°, 90°, 180°, and 270°.

This setting is ideal for omnidirectional recording of a conversation between four people seated at a round table.

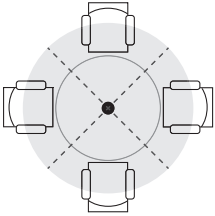

- When connecting to the ATDM series DIGITAL SMARTMIXER™, the input type for input channels 1-3 is set to "Virtual Mic" by default, however, if the sound pickup coverage is to be divided into four or more sections as shown in this example, set the input type to "Virtual Mic" for input channels 4 and onward. For detailed operating instructions, refer to the ATDM series DIGITAL SMARTMIXER™ user manuals.

For 300° coverage

Creates three cardioid (Wide) virtual directional patterns at 0°, 90°, and 180°.

This setting is ideal for picking up a conversation between three people seated at the end of a table.

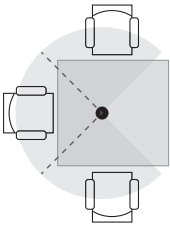

When installing 2 or more of this product

We recommend that the microphones be placed at least 1.7 m (5.6') (for the hypercardioid (Normal) setting) apart so that the coverages of each microphone do not overlap.

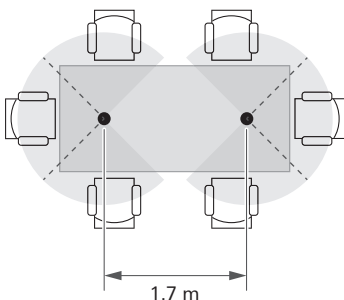

Mixer settings

Using with ATDM series DIGITAL SMARTMIXER™

- The firmware of the ATDM series DIGITAL SMARTMIXER™ should be up-to-date before use.

1 Start the web remote, select “Administrator” and log in.

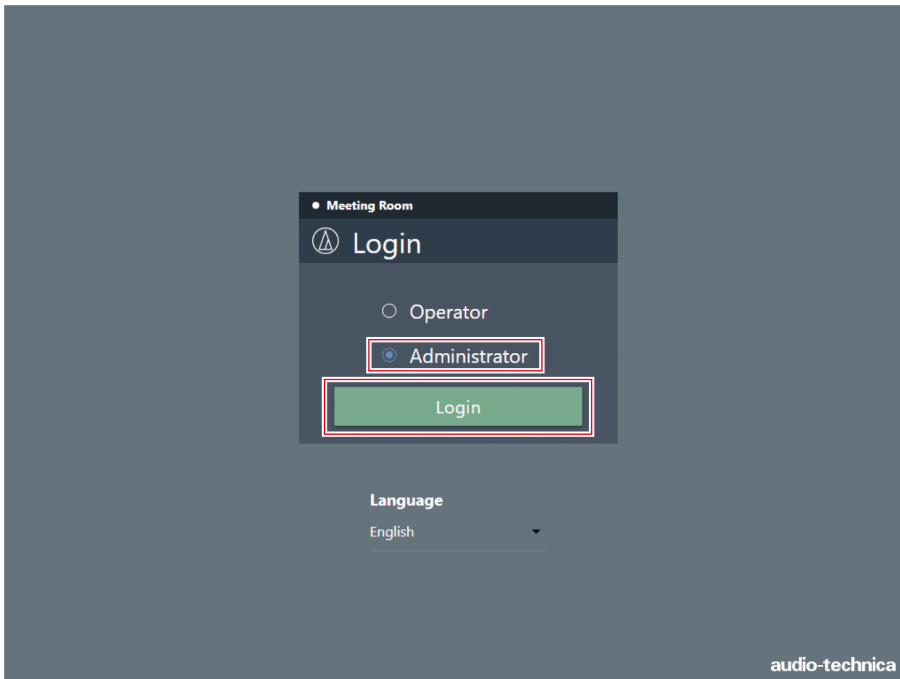

2 For subsequent settings and operations, refer to the ATDM series DIGITAL SMARTMIXER™ User Manual.

When using other mixers

When using the product with a mixer other than the ATDM series DIGITAL SMARTMIXER™, you can adjust the output of each channel according to the following mixing matrix to control the directionality.

When mixing matrix is “Normal”

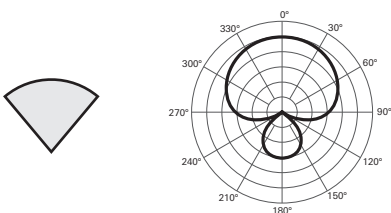

Mixer settings

Pickup direction	O		L		R	
	ϕ	Level	ϕ	Level	ϕ	Level
0°	+	-4 dB	-	0 dB	-	0 dB
30°	+	-4 dB	-	+1.2 dB	-	-4.8 dB
60°	+	-4 dB	-	0 dB		-∞
90°	+	-4 dB	-	-4.8 dB	+	-4.8 dB
120°	+	-4 dB		-∞	+	0 dB
150°	+	-4 dB	+	-4.8 dB	+	+1.2 dB
180°	+	-4 dB	+	0 dB	+	0 dB
210°	+	-4 dB	+	+1.2 dB	+	-4.8 dB
240°	+	-4 dB	+	0 dB		-∞
270°	+	-4 dB	+	-4.8 dB	-	-4.8 dB
300°	+	-4 dB		-∞	-	0 dB
330°	+	-4 dB	-	-4.8 dB	-	+1.2 dB

When mixing matrix is "Wide"

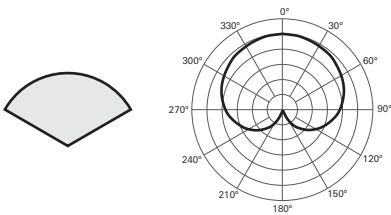

Pickup direction	O		L		R	
	ϕ	Level	ϕ	Level	ϕ	Level
0°	+	0 dB	-	0 dB	-	0 dB
30°	+	0 dB	-	+1.2 dB	-	-4.8 dB
60°	+	0 dB	-	0 dB		-∞
90°	+	0 dB	-	-4.8 dB	+	-4.8 dB
120°	+	0 dB		-∞	+	0 dB
150°	+	0 dB	+	-4.8 dB	+	+1.2 dB
180°	+	0 dB	+	0 dB	+	0 dB
210°	+	0 dB	+	+1.2 dB	+	-4.8 dB
240°	+	0 dB	+	0 dB		-∞
270°	+	0 dB	+	-4.8 dB	-	-4.8 dB
300°	+	0 dB		-∞	-	0 dB
330°	+	0 dB	-	-4.8 dB	-	+1.2 dB

Using the product

Switching between mute and unmute

1 Touch a talk switch once.

- Each time you touch a talk switch, the microphone switches between mute/unmute.
- You can change the mute operation setting with the "SW. FUNCTION" switch. For details, see "Switch setting and functions" (p. 17).

» The talk indicator lamp lights.

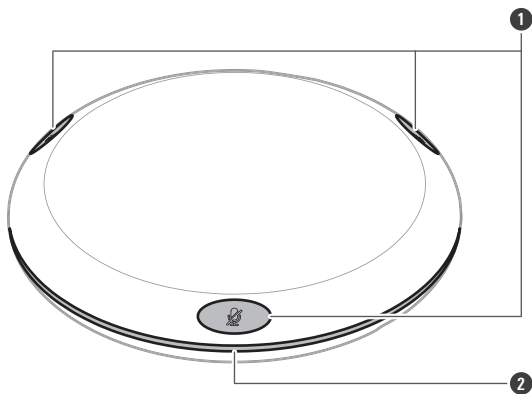

- 1 Talk switches
- 2 Talk indicator lamp



- You can change the LED color of the talk indicator lamp with the "MIC ON" and "MIC OFF" dials under "LED COLOR." For details, see "Setting LED colors" (p. 18).

Switch setting and functions

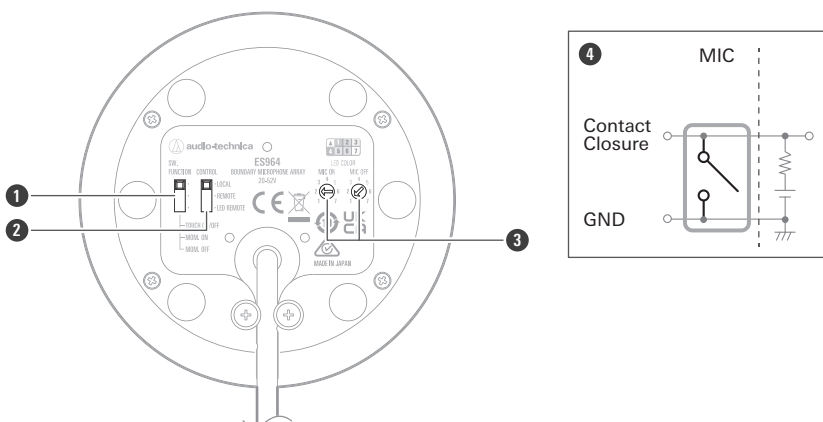

- 1 SW. FUNCTION
- 2 CONTROL
- 3 LED COLOR
- 4 Contact closure status (microphone operation status)

Using the product

Setting LED colors

You can select the LED color of the talk indicator lamp that lights when the microphone is turned on/off.

- 1 Turn the "MIC OFF" / "MIC ON" dial to the number of the color you wish to set for that mic on/off status.

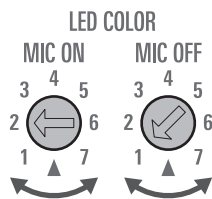

Number	LED color
▲	Not lit
1	Red
2	Green
3	Yellow
4	Blue
5	Magenta
6	Cyan
7	White

If CONTROL is "LOCAL"

You can set the operation mode to one of three modes: "TOUCH ON/OFF" (touch-on/touch-off), "MOM. ON" (touch-to-talk), or "MOM. OFF" (touch-to-mute).

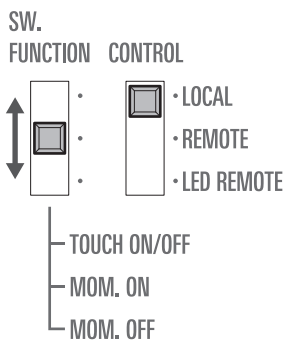

Using the product

If the SW. FUNCTION is "TOUCH ON/OFF" (touch-on/touch-off)

Each time you touch a talk switch, the microphone is turned on and off.

When the microphone is turned on, the LED lights in the color selected under "MIC ON," and when it is turned off, the LED lights in the color selected under "MIC OFF."

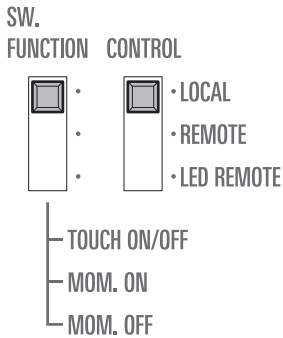

Action	Contact closure status	Audio status	LED color	LED status
			<div style="display: flex; justify-content: space-around;"> <div style="text-align: center;"> <p>MIC ON</p> </div> <div style="text-align: center;"> <p>MIC OFF</p> </div> </div>	
			<div style="display: flex; justify-content: space-around;"> <div style="text-align: center;"> <p>MIC ON</p> </div> <div style="text-align: center;"> <p>MIC OFF</p> </div> </div>	







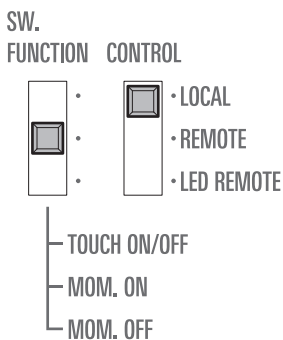

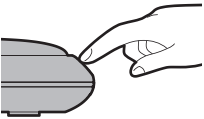

If the SW. FUNCTION is "MOM. ON" (touch-to-talk)

The microphone is turned on as long as you are touching a talk switch. The microphone is turned off when you stop touching the talk switch.

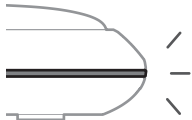
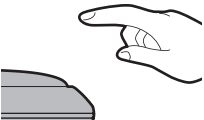
When the microphone is turned on, the LED lights in the color selected under "MIC ON," and when it is turned off, the LED lights in the color selected under "MIC OFF."



Using the product

Action	Contact closure status	Audio status	LED color	LED status
			<div style="display: flex; justify-content: space-around;"> <div style="text-align: center;"> <p>MIC ON</p>  </div> <div style="text-align: center;"> <p>MIC OFF</p>  </div> </div>	
			<div style="display: flex; justify-content: space-around;"> <div style="text-align: center;"> <p>MIC ON</p>  </div> <div style="text-align: center;"> <p>MIC OFF</p>  </div> </div>	

If the SW. FUNCTION is "MOM. OFF" (touch-to-mute)

The microphone is turned off as long as you are touching a talk switch. The microphone is turned on when you stop touching the talk switch.







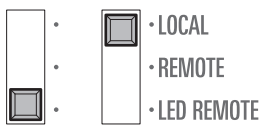

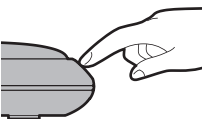

When the microphone is turned off, the LED lights in the color selected under "MIC OFF," and when it is turned on, the LED lights in the color selected under "MIC ON."

SW.

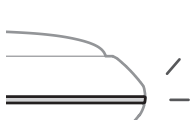
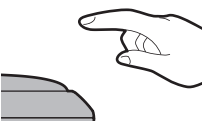
FUNCTION CONTROL



- TOUCH ON/OFF
- MOM. ON
- MOM. OFF

Action	Contact closure status	Audio status	LED color	LED status
			<div style="display: flex; justify-content: space-around;"> <div style="text-align: center;"> <p>MIC ON</p>  </div> <div style="text-align: center;"> <p>MIC OFF</p>  </div> </div>	
			<div style="display: flex; justify-content: space-around;"> <div style="text-align: center;"> <p>MIC ON</p>  </div> <div style="text-align: center;"> <p>MIC OFF</p>  </div> </div>	

Using the product

If CONTROL is "REMOTE"

You can set the operation mode to one of three modes: "TOUCH ON/OFF" (touch-on/touch-off), "MOM. ON" (touch-to-talk), or "MOM. OFF" (touch-to-mute). However, the microphone remains on in any of these modes, and only the lighting of the talk indicator lamp switches.

The microphone is switched on and off by the external control device.

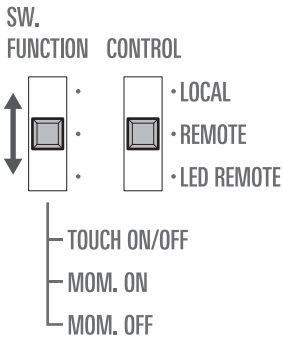

If the SW. FUNCTION is "TOUCH ON/OFF" (touch-on/touch-off)

Each time you touch a talk switch, the talk indicator lamp that indicates whether the microphone is on/off switches.

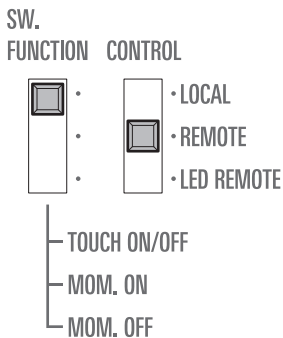





Action	Contact closure status	Audio status	LED color	LED status
			<p>MIC ON MIC OFF</p>	
			<p>MIC ON MIC OFF</p>	

Using the product

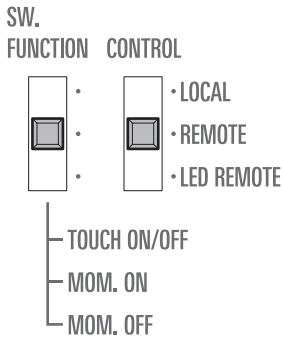
If the SW. FUNCTION is "MOM. ON" (touch-to-talk)

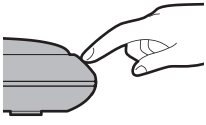
The talk indicator lamp that indicates that the microphone is on lights while you are touching a talk switch, and the talk indicator lamp that indicates that the microphone is off lights when you stop touching the talk switch.

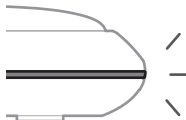
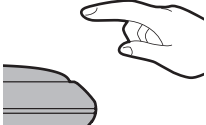

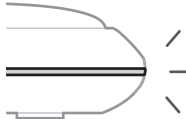



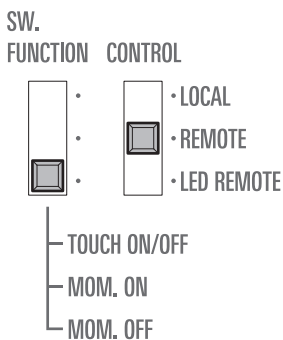

Action	Contact closure status	Audio status	LED color	LED status				
			<table border="0"> <tr> <td style="text-align: center;">MIC ON</td> <td style="text-align: center;">MIC OFF</td> </tr> <tr> <td style="text-align: center;">3 4 5 2 ← 6 1 ▲ 7</td> <td style="text-align: center;">3 4 5 2 ↘ 6 1 ▲ 7</td> </tr> </table>	MIC ON	MIC OFF	3 4 5 2 ← 6 1 ▲ 7	3 4 5 2 ↘ 6 1 ▲ 7	
MIC ON	MIC OFF							
3 4 5 2 ← 6 1 ▲ 7	3 4 5 2 ↘ 6 1 ▲ 7							
			<table border="0"> <tr> <td style="text-align: center;">MIC ON</td> <td style="text-align: center;">MIC OFF</td> </tr> <tr> <td style="text-align: center;">3 4 5 2 ← 6 1 ▲ 7</td> <td style="text-align: center;">3 4 5 2 ↘ 6 1 ▲ 7</td> </tr> </table>	MIC ON	MIC OFF	3 4 5 2 ← 6 1 ▲ 7	3 4 5 2 ↘ 6 1 ▲ 7	
MIC ON	MIC OFF							
3 4 5 2 ← 6 1 ▲ 7	3 4 5 2 ↘ 6 1 ▲ 7							

If the SW. FUNCTION is "MOM. OFF" (touch-to-mute)

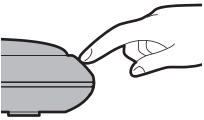
The talk indicator lamp that indicates that the microphone is off lights while you are touching a talk switch. The talk indicator lamp that indicates that the microphone is on lights when you stop touching the talk switch.

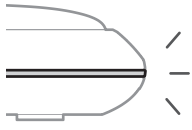
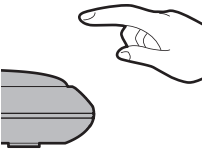

Using the product

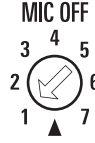
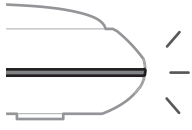
Action	Contact closure status	Audio status	LED color	LED status
				
				

If CONTROL is "LED REMOTE"

You can set the operation mode to one of three modes: "TOUCH ON/OFF" (touch-on/touch-off), "MOM. ON" (touch-to-talk), or "MOM. OFF" (touch-to-mute). However, the microphone remains on in any of these modes, and the lighting of the talk indicator lamp does not switch.

The microphone is switched on and off and the lighting of the talk indicator lamp is switched by an external control device.

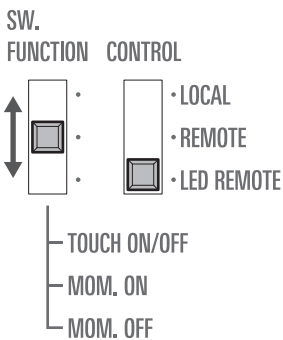

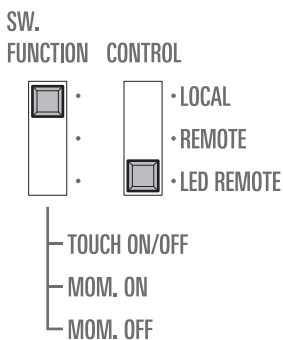

If the SW. FUNCTION is "TOUCH ON/OFF" (touch-on/touch-off)

The microphone does not switch on/off even if you touch a talk switch. The lighting of the talk indicator lamp is not directly linked to the operation of the microphone body. It is instead controlled by an external device.



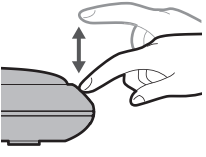
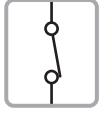

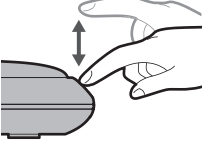
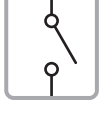
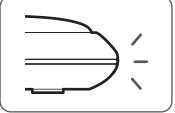

Using the product

Action	Contact closure status	Audio status	LED color	LED status								
			<table border="0"> <tr> <td>MIC ON</td> <td>MIC OFF</td> </tr> <tr> <td>3 4 5</td> <td>3 4 5</td> </tr> <tr> <td>2 ← 6</td> <td>2 → 6</td> </tr> <tr> <td>1 ▲ 7</td> <td>1 ▲ 7</td> </tr> </table>	MIC ON	MIC OFF	3 4 5	3 4 5	2 ← 6	2 → 6	1 ▲ 7	1 ▲ 7	
MIC ON	MIC OFF											
3 4 5	3 4 5											
2 ← 6	2 → 6											
1 ▲ 7	1 ▲ 7											
		<table border="0"> <tr> <td>MIC ON</td> <td>MIC OFF</td> </tr> <tr> <td>3 4 5</td> <td>3 4 5</td> </tr> <tr> <td>2 ← 6</td> <td>2 → 6</td> </tr> <tr> <td>1 ▲ 7</td> <td>1 ▲ 7</td> </tr> </table>	MIC ON	MIC OFF	3 4 5	3 4 5	2 ← 6	2 → 6	1 ▲ 7	1 ▲ 7		
MIC ON	MIC OFF											
3 4 5	3 4 5											
2 ← 6	2 → 6											
1 ▲ 7	1 ▲ 7											

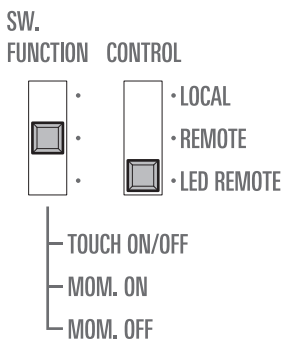
If the SW. FUNCTION is "MOM. ON" (touch-to-talk)

The microphone does not switch on/off while you are touching a talk switch or while you are not touching a talk switch. The lighting of the talk indicator lamp is not directly linked to the operation of the microphone body. It is instead controlled by an external device.

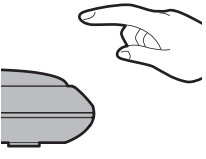
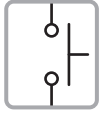
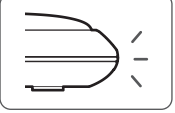

Action	Contact closure status	Audio status	LED color	LED status								
			<table border="0"> <tr> <td>MIC ON</td> <td>MIC OFF</td> </tr> <tr> <td>3 4 5</td> <td>3 4 5</td> </tr> <tr> <td>2 ← 6</td> <td>2 → 6</td> </tr> <tr> <td>1 ▲ 7</td> <td>1 ▲ 7</td> </tr> </table>	MIC ON	MIC OFF	3 4 5	3 4 5	2 ← 6	2 → 6	1 ▲ 7	1 ▲ 7	
MIC ON	MIC OFF											
3 4 5	3 4 5											
2 ← 6	2 → 6											
1 ▲ 7	1 ▲ 7											
		<table border="0"> <tr> <td>MIC ON</td> <td>MIC OFF</td> </tr> <tr> <td>3 4 5</td> <td>3 4 5</td> </tr> <tr> <td>2 ← 6</td> <td>2 → 6</td> </tr> <tr> <td>1 ▲ 7</td> <td>1 ▲ 7</td> </tr> </table>	MIC ON	MIC OFF	3 4 5	3 4 5	2 ← 6	2 → 6	1 ▲ 7	1 ▲ 7		
MIC ON	MIC OFF											
3 4 5	3 4 5											
2 ← 6	2 → 6											
1 ▲ 7	1 ▲ 7											

If the SW. FUNCTION is "MOM. OFF" (touch-to-mute)

The microphone does not switch on/off while you are touching a talk switch or while you are not touching a talk switch. The lighting of the talk indicator lamp is not directly linked to the operation of the microphone body. It is instead controlled by an external device.

Using the product

SW.

FUNCTION CONTROL

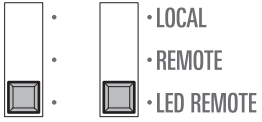

- TOUCH ON/OFF
- MOM. ON
- MOM. OFF

Action	Contact closure status	Audio status	LED color	LED status
			<p>MIC ON MIC OFF</p>	
			<p>MIC ON MIC OFF</p>	

Cleaning

Get into the habit of regularly cleaning the product to ensure that it will last for a long time. Do not use alcohol, paint thinners, or other solvents for cleaning purposes.

- Wipe dirt off the product with a dry cloth.
- If the cables become dirty because of sweat, etc., wipe them with a dry cloth immediately after use. Failure to clean the cables may cause them to deteriorate and harden over time, resulting in a malfunction.



- If the product will not be used for an extended period of time, store it in a well-ventilated place free from high temperatures and humidity.

Troubleshooting

① Microphone produces no sound

- Make sure that output terminals A and B are connected to the correct connection point.
- Make sure that breakout cables A and B are connected to the correct connection point.
- Make sure that the connection cables are properly connected.
- Make sure that the connected device is supplying phantom power properly.
- Make sure that the external control device is not set to mute.

① Talk indicator lamp does not light

- Make sure that the “MIC ON” / “MIC OFF” dial for “LED COLOR” is not set to “▲” (no lighting).
- Make sure that the connected device is supplying phantom power properly and that the voltage is correct.
- Make sure that the external control device is not set to turn off the talk indicator lamp.

Specifications

Element	Fixed-charge back plate, permanently polarized condenser
Polar pattern	Adjustability: Cardioid (Wide) / Hypercardioid (Normal)
Frequency response	20 to 15,000 Hz
Open circuit sensitivity	Wide: -33 dBV (22.4 mV) (0 dB = 1 V/Pa, 1 kHz) Normal: -35 dBV (17.8 mV) (0 dB = 1 V/Pa, 1 kHz)
Impedance	100 ohms
Maximum input sound level	Wide/Normal: 136.5 dB SPL (1 kHz at 1% THD)
Signal-to-noise ratio	Wide: 68.5 dB (1 kHz at 1 Pa, A-weighted) Normal: 67.5 dB (1 kHz at 1 Pa, A-weighted)
Switch	SW. FUNCTION: TOUCH ON/OFF, MOM. ON, MOM. OFF CONTROL: LOCAL, REMOTE, LED REMOTE
Phantom power requirements	20 to 52 V DC, 19.8 mA (all channels total)
Contact closure	Closure input voltage: -0.5 to 5.5 V Maximum permissible power: 200 mW On-resistance: 100 ohms
LED control	Active high (+5 V DC) TTL compatible Active low voltage: 1.2 V or lower Maximum permissible input power: -0.5 to 5.5 V Maximum permissible power: 200 mW
Weight	Microphone: 364 g (13 oz)
Dimensions (microphone)	Maximum diameter (body): 88 mm (3.5") Height: 22 mm (0.87")
Output connector	Euroblock connector
Included accessories	RJ45 breakout cable × 2, table mount adapter, fixing nut, rubber isolator, table mount adapter mounting screw × 3

- 1 Pascal = 10 dynes/cm² = 10 microbars = 94 dB SPL
- For product improvement, the product is subject to modification without notice.

Polar pattern/Frequency response

Hypercardioid (Normal)

Polar pattern

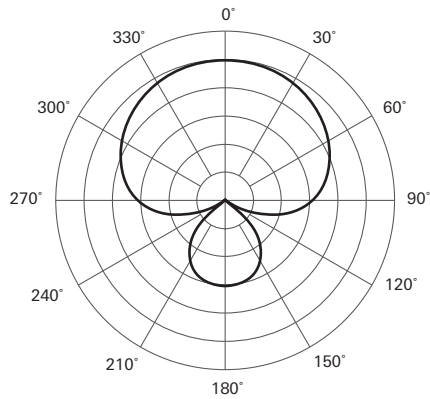

LEGEND



Frequency response

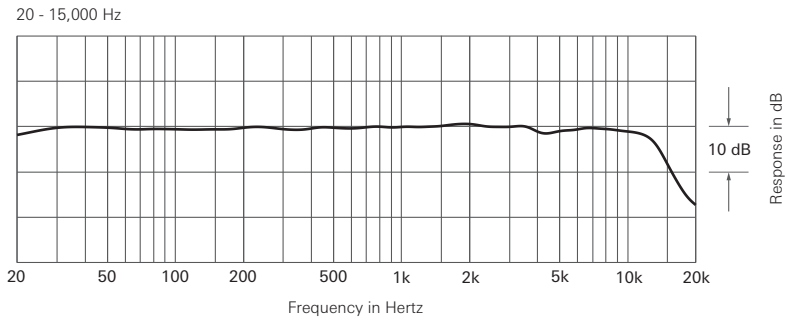

LEGEND

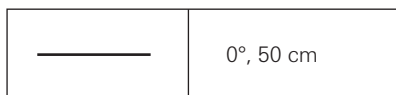

Cardioid (Wide)

Polar pattern

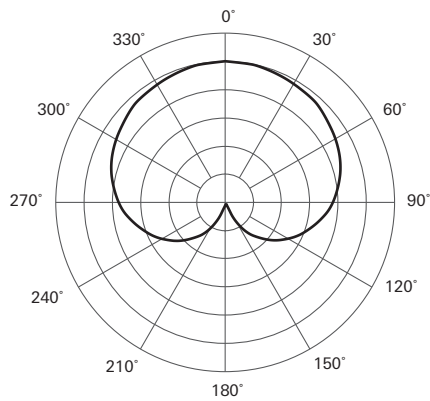

LEGEND

	1 kHz	SCALE IS 5 DECIBELS PER DIVISION
--	-------	-------------------------------------

Frequency response

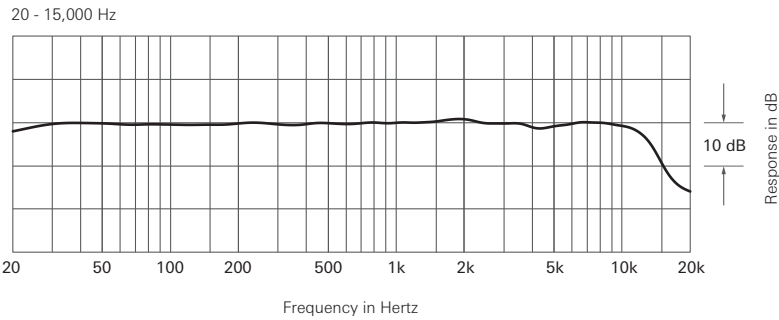

LEGEND

	0°, 50 cm
---	-----------

Trademarks

- SMARTMIXER™ is a trademark or registered trademark of Audio-Technica Corporation.

株式会社オーディオテクニカ

〒194-8666 東京都町田市西成瀬2-46-1
www.audio-technica.co.jp

Audio-Technica Corporation

2-46-1 Nishi-naruse, Machida, Tokyo 194-8666, Japan
www.audio-technica.com
©2023 Audio-Technica Corporation
Global Support Contact: www.at-globalsupport.com