



**audio-technica**

# **ATH-TWX9**

Wireless Headphones

---

## **User Manual**

English

# Safety precautions

Although this product was designed to be used safely, failing to use it correctly may result in an accident. To ensure safety, observe all warnings and cautions while using the product.

## Cautions for the headphones

- Do not use the product near medical equipment. Radio waves may affect cardiac pacemakers and medical electronic equipment. Do not use the product inside medical facilities.
- When using the product in aircraft, follow airline instructions.
- Do not use the product near automatic control devices such as automatic doors and fire alarms. Radio waves may affect electronic equipment and cause accidents due to malfunction.
- Do not disassemble, modify or attempt to repair the product to avoid electric shock, malfunction or fire.
- Do not subject the product to strong impact to avoid electric shock, malfunction or fire.
- Do not handle the product with wet hands to avoid electric shock or injury.
- Disconnect the product from a device if the product begins to malfunction, producing smoke, odor, heat, unwanted noise or showing other signs of damage. In such a case, contact your local Audio-Technica dealer.
- Do not allow the product to get wet to avoid electric shock or malfunction.
- Do not put foreign matter such as combustible materials, metal, or liquid in the product.
- Do not cover the product with a cloth to avoid fire or injury by overheating.
- Follow applicable laws regarding mobile phone and headphone use if using headphones while driving.
- Do not use the product in places where the inability to hear ambient sound presents a serious risk (such as at railroad crossings, train stations, and construction sites).
- The product effectively shields external sound, so you may not hear sound around you clearly while wearing the product. Adjust the volume to a level where you can still hear background sound and monitor the area around you while listening to music.
- Store the product out of the reach of small children.
- To prevent damage to your hearing, do not raise the volume too high. Listening to loud sound for an extended period may cause temporary or permanent hearing loss.
- Discontinue use if skin irritation results from direct contact with the product.
- If you begin to feel unwell while using the product, discontinue use immediately.
- When removing the product from your ears, check to make sure the eartips are still attached to the main unit. If the eartips become lodged in your ears and you are unable to remove them, consult a physician at once.
- If you develop an itch from wearing the product, discontinue use.

## Cautions for charging case

- Do not disassemble, modify or attempt to repair the product to avoid electric shock, malfunction or fire.
- Do not subject the product to strong impact to avoid electric shock, malfunction or fire.
- Do not handle the product with wet hands to avoid electric shock or injury.
- Disconnect the product from a device if the product begins to malfunction, producing smoke, odor, heat, unwanted noise or showing other signs of damage. In such a case, contact your local Audio-Technica dealer.
- Do not allow the product to get wet to avoid electric shock or malfunction.
- Do not put foreign matter such as combustible materials, metal, or liquid in the product.

## Safety precautions

- Do not cover the product with a cloth to avoid fire or injury by overheating.
- Do not charge the battery if the terminal of the USB charging cable is bent, loose, or damaged. Doing so may cause heat generation, smoke emission, fire or electric shock.
- Do not charge the product if water or foreign matter is inside the battery jack or USB charging cable. Doing so may cause corrosion, heat generation, smoke, fire, or other malfunction or electric shock in the battery jack or USB charging cable.
- When charging, make sure to use the included USB charging cable.
- Do not charge with devices that have quick-charge functionality (with a voltage of 5 V or more). Doing so may cause the product to malfunction.
- Do not store the product in direct sunlight, near heating devices, or in hot, humid, or dusty places because such storage could cause malfunction or defect.
- Do not put the product close to fire because that could cause deformation or malfunction.
- Do not use benzine, paint thinners and electrical contact cleaner, etc. because use of such material could cause deformation or malfunction.

## Cautions for rechargeable battery

The headphones and charging case are equipped with a rechargeable battery (lithium-ion battery).

- If battery fluid gets into eyes, do not rub them. Rinse thoroughly with clean water such as tap water and consult a doctor immediately.
- If battery fluid leaks, do not touch fluid with bare hands. If fluid remains inside the product, it may cause malfunction. If battery fluid leaks, contact your local Audio-Technica dealer.
  - If fluid gets in your mouth, gargle thoroughly with clean water such as tap water and consult a doctor immediately.
  - If your skin or clothing comes in contact with fluid, immediately wash the affected skin or clothing with water. If you experience skin irritation, consult a doctor.
- To avoid leakage, generation of heat or explosion:
  - Never heat, disassemble or modify the battery, nor dispose of it in a fire.
  - Do not attempt to pierce with a nail, hit with a hammer or step on the battery.
  - Do not drop the product or subject it to strong impact.
  - Do not get the battery wet.
- Do not use, leave or store the battery in the following places:
  - Area exposed to direct sunlight or high temperatures and humidity
  - Inside of a car under the blazing sun
  - Near heat sources such as heat registers
- Charge only with the included USB cable to avoid malfunction or fire.
- The internal rechargeable battery of this product cannot be replaced by the user. The battery may have reached the end of its service life if the usage time becomes significantly shorter even after the battery has been fully charged. If this is the case, the battery needs to be repaired. Contact your local Audio-Technica dealer for repair details.
- When the product is disposed of, the built-in rechargeable battery needs to be discarded properly. Contact your local Audio-Technica dealer to learn how to properly dispose of the battery.

# For customers in the USA

## FCC Notice

### Warning

This device complies with Part 15 of the FCC Rules. Operation is subject to the following two conditions: (1) This device may not cause harmful interference, and (2) this device must accept any interference received, including interference that may cause undesired operation.

### Caution

You are cautioned that any changes or modifications not expressly approved in this manual could void your authority to operate this equipment.

Note: This equipment has been tested and found to comply with the limits for a Class B digital device, pursuant to part 15 of the FCC Rules. These limits are designed to provide reasonable protection against harmful interference in a residential installation. This equipment generates, uses and can radiate radio frequency energy and, if not installed and used in accordance with the instructions, may cause harmful interference to radio communications. However, there is no guarantee that interference will not occur in a particular installation. If this equipment does cause harmful interference to radio or television reception, which can be determined by turning the equipment off and on, the user is encouraged to try to correct the interference by one or more of the following measures:

- Reorient or relocate the receiving antenna.
- Increase the separation between the equipment and receiver.
- Connect the equipment to an outlet on a circuit different from that to which the receiver is connected.
- Consult the dealer or an experienced radio/TV technician for help.

This transmitter must not be co-located or operated in conjunction with any other antenna or transmitter used in other systems.

### RF Exposure Statement

This device complies with FCC radiation exposure limits set forth for an uncontrolled environment and meets the FCC radio frequency (RF) Exposure Guidelines. This equipment has very low levels of RF energy that is deemed to comply without testing of specific absorption rate (SAR).

### Contact:

Responsible Company: Audio-Technica U.S., Inc.  
Address: 1221 Commerce Drive, Stow, Ohio 44224, USA  
Tel: 330-686-2600

# For customers in Canada

## ISED statement

CAN ICES-3 (B)/NMB-3(B)

This device contains licence-exempt transmitter(s)/receiver(s) that comply with Innovation, Science and Economic Development Canada's licence-exempt RSS(s).

Operation is subject to the following two conditions:

## Safety precautions

(1) This device may not cause interference.

(2) This device must accept any interference, including interference that may cause undesired operation of the device.

This device complies with RSS-102 radiation exposure limits set forth for an uncontrolled environment.

# Notes on use

- Be sure to read the connected device's user manual before use.
- Audio-Technica will not be liable in any way for any loss of data in the unlikely event that such losses should occur while using the product.
- On public transportation or in other public places, keep the volume low so as not to disturb other people.
- Minimize the volume on your device before connecting the product.
- When using the product in a dry environment, you may feel a tingling sensation in your ears. This is caused by static electricity accumulated on your body, not by product malfunction.
- Do not subject the product to strong impact.
- Do not store the product in direct sunlight, near heating devices, or in hot, humid, or dusty places. Additionally, do not allow the product to get wet.
- When the product is used for a long time, the product may become discolored due to ultraviolet light (especially direct sunlight) and wear.
- If the charging case is placed in a bag while the USB charging cable is still connected, the USB charging cable may become caught, severed, or broken.
- Make sure to hold the plug when connecting and disconnecting the USB charging cable. The USB charging cable may become severed or an accident may occur if you pull on the cable itself.
- When you are not using the USB charging cable, disconnect it from the charging case.
- When you are not using the product, store it in the included charging case.
- If you use eartips other than those included, the headphones may not fit into the charging case, or may not charge. Be sure to use the included eartips.
- When using the product, select the eartips that fit your ears best, and wear the product securely.
- This product can be used to talk on the phone only when using a mobile telephone network. Support for telephony apps that use a mobile data network is not guaranteed.
- If you use the product near an electronic device or transmitter (such as a mobile phone), unwanted noise may be heard. In this case, move the product away from the electronic device or transmitter.
- If you use the product near a TV or radio antenna, noise may be seen or heard in the television or radio signal. In this case, move the product away from the TV or radio antenna.
- To protect the built-in rechargeable battery, charge it at least once every 6 months. If too much time passes between charges, the life of the rechargeable battery may be reduced, or the rechargeable battery may no longer be able to be charged.
- Charge the product in a well-ventilated place (10 to 35°C (50 to 95°F)) away from direct sunlight. Otherwise, the battery may deteriorate, possibly resulting in shorter periods of continuous use or may fail to charge.
- If the headphones are wet, wipe them with a dry cloth before placing them in the charging case. The charging case is not water-resistant (drip-proof). Do not charge the product if the headphones are wet.
- The hear-through function of the product allows you to hear the sounds around you through the built-in microphone. Depending on the volume of the music being played back, the surrounding sounds may be difficult to hear. In this case, turn down the volume of the music.
- Depending on your surroundings, the ambient sounds may be difficult to hear even when using the product's hear-through function. Do not use the product in places that are dangerous if you cannot hear the surrounding sounds, such as places with heavy traffic.
- Operate the touch sensor with one finger. Operating with a sharp-tipped object, such as a ballpoint pen or pencil, may result not only in incorrect operation, but also damage to the touch sensor.
- Do not touch the touch sensor with your fingertips. Doing so may cause your fingernail to break.

## Notes on use

- If the product does not operate at all or as intended when touched, check to make sure that your other fingers, parts of your hand, or clothing items are not in contact when touching. Also, the product may not operate correctly if you are wearing gloves or if your fingertips are too dry.
- The product may not operate correctly if the touch sensor is dirty from sweat. Remove the dirt before operating the product.

# About the active noise-cancelling function

The product is designed to use its built-in microphone to pick up noise from the surrounding environment (noise from vehicles, noise from air conditioners, etc.) and to cancel out that noise by producing sounds in negative phase. This results in a reduction in the sounds in your environment.

- The product's noise-cancelling function is mainly effective against noises in the lower frequency range, but not all noises are cancelled.
- Depending on the type of noise (or in quiet locations), you may not notice the noise-cancelling effect.
- A slight humming sound may be heard when using the noise-cancelling function. This is a sound generated by the noise-cancelling function; it is not a malfunction.
- The noise-cancelling effect may vary or a bleep (howling) may occur depending on how you wear the product. In these cases, take off the product and put the product in your ears again correctly.
- To maximize the noise-cancelling effect, select the eartips that offer the best sound insulation for each side to block surrounding sound, and insert the headphones into the ears correctly.
- When you use the product in a train or a vehicle such as bus or truck, noise may be heard depending on rail/street conditions.



# About water-resistant (drip-proof) performance

- The water-resistant (drip-proof) specification of this product applies only to the headphones, not the charging case.
- Although the headphones have water-resistant (drip-proof) capabilities equivalent to IPX4, the part where the sound comes from is not water-resistant (drip-proof).
- The water-resistant (drip-proof) performance is designed to protect the headphones if they get wet from rain, etc. (equivalent to IPX4). JIS/IEC protection grade IPX4 means that the product is protected against exposure to flying water from all directions.
- The headphones cannot be used underwater.
- The headphones cannot be used in hot and humid places, such as bathrooms.
- The headphones are not waterproof. Submerging them in water may cause damage.
- The headphones may not function properly if they become wet. Wipe the headphones with a dry cloth, shake them multiple times to remove any excess water, and allow the headphones to dry thoroughly before use.

# About the sanitization function

## Sanitizing the headphones

When the headphones are placed in the charging case and the cover is closed, the headphones will be automatically sanitized using a deep UV LED.

- Only the surface of the eartips is sanitized.
- To prevent the deep UV LED from being directly visible, the sanitization function is activated only after the charging case cover has been closed.

### 1 Place the headphones in the charging case and close the cover.

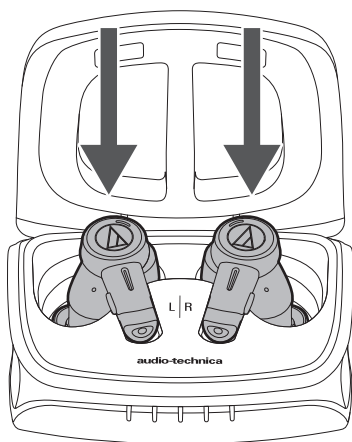

### 2 The headphones will be automatically sanitized using a deep UV LED.

- The indicator lamp on the charging case will flash in purple while sanitization is in progress (flashing occurs from the center towards both ends). Do not open the charging case cover if the indicator lamp is flashing in purple.
- Opening the charging case cover while sanitization is in progress would cause the deep UV LED to turn off and the sanitization function to stop.

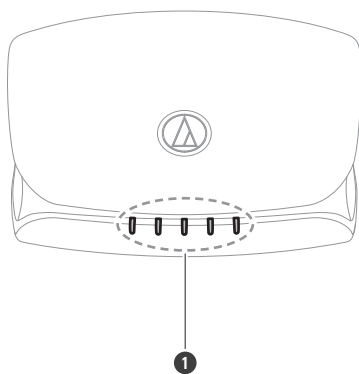

1 Charging indicator lamps

» Once sanitization is complete, the indicator lamps turn off.

## About the sanitization function



- Once sanitization by the deep UV LED is complete, sanitization will not be performed again for approximately 1 hour, even if the headphones are placed in the charging case. However, if sanitization is stopped due to the charging case cover being opened, it will restart once the cover is closed again, even within 1 hour.

### Notes for sanitization

- Sanitization using the deep UV LED will not be performed if the headphones are not placed in the charging case correctly.
- Sanitization of objects other than the headphones is not possible. Do not place any object other than the headphones inside the charging case.
- The indicator lamp on the charging case will flash in purple while sanitization is in progress. Do not open the charging case cover if the indicator lamp is flashing in purple.
- If the product begins to operate abnormally, such as if the deep UV LED glows when the cover of the charging case is open, immediately stop using the product and contact your local Audio-Technica dealer.

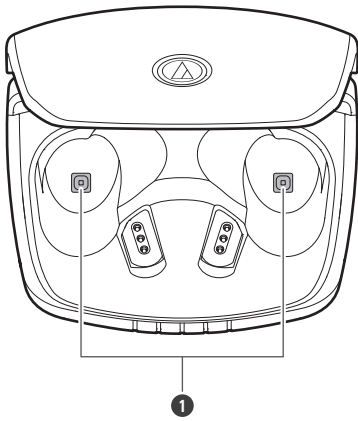

1 Deep UV LED

# For a more comfortable Bluetooth communication experience

The effective communication range of this product varies depending on obstructions and radio wave conditions. For a more enjoyable experience, please use the product as close as possible to the Bluetooth device. To minimize noise and sound disruptions, avoid placing your body or other obstacles between the product's antenna and the Bluetooth device.

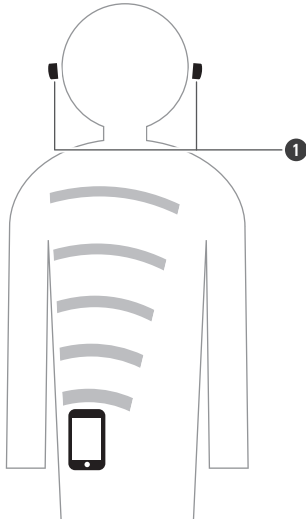

① Antenna

# Part names and functions

## Headphones

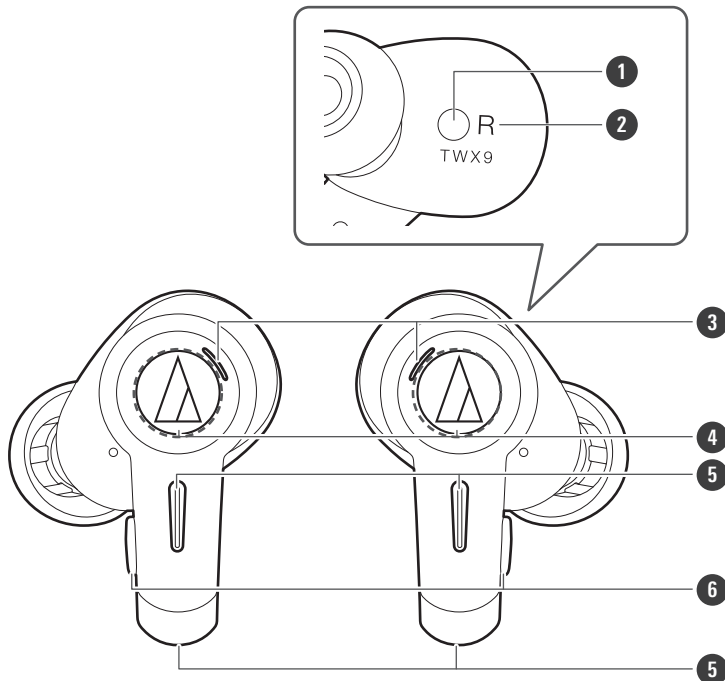

**1 Ear detection sensor**

**2 L/R (left/right) indicator**

**3 Indicator lamps**

Display the operating status and battery level of the headphones.

**4 Touch sensors**

Use to operate specific functions, such as turning ambience control on and off.

**5 Microphones**

**6 Multifunction buttons**

Use to play/pause music and answer phone calls. Also use to adjust the volume (+/-).

### Charging case

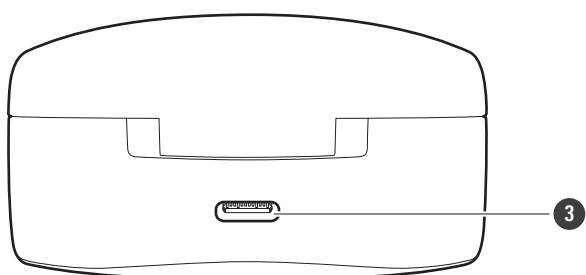
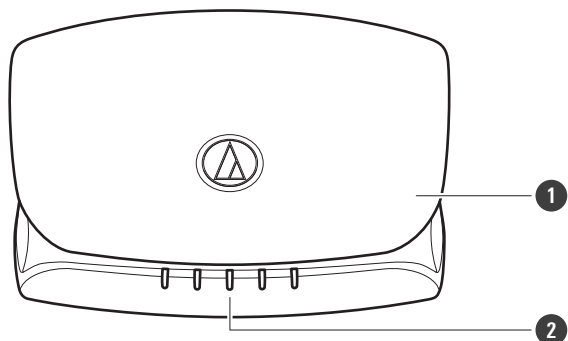

**1 Cover**

**2 Charging indicator lamps**

Light/flash when charging the charging case. Also display the battery level of the charging case and headphones.

**3 Battery jack**

Use to connect the included USB charging cable and charge the product.

### Accessories

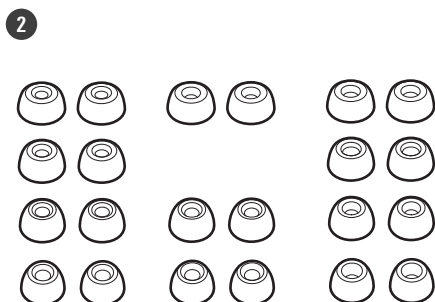
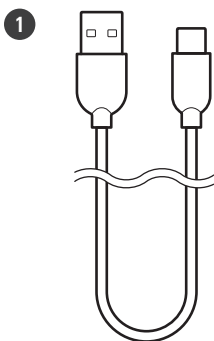

**1 USB charging cable (30 cm (12"), USB Type-A / USB Type-C)**

**2 Eartips (XS, S, M, L)**

At the time of purchase, the M-size (standard) eartips are attached to the product.

### Removing the insulation seals

Remove the insulation seals before use.

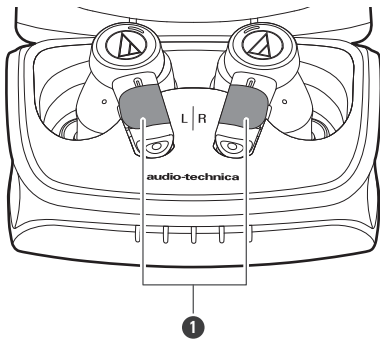

1 Insulation seals

# Charging the battery

- Fully charge the battery when using for the first time.
- When the rechargeable battery is running low, the voice guidance will play the message “Low battery”, and the indicator lamp will flash in red. Charge the battery as soon as possible.
- It takes about 2.5 hours to fully charge the headphones and about 3.5 hours to fully charge the charging case. (This time may vary depending on usage conditions.)
- Charge the product in a well-ventilated place (10 to 35°C (50 to 95°F)) away from direct sunlight. Charging outside the normal charging temperature range may result in failure to charge or longer charging time. Otherwise, the battery may deteriorate, possibly resulting in shorter periods of continuous use or may fail to charge.

## Charging the headphones and charging case

### 1 Connect the included USB charging cable (USB Type-C side) to the battery jack.

- The included USB charging cable is designed for exclusive use with the product. Do not use any other USB charging cable.
- When inserting the USB charging cable into the USB port or battery jack, insert it directly (horizontally).

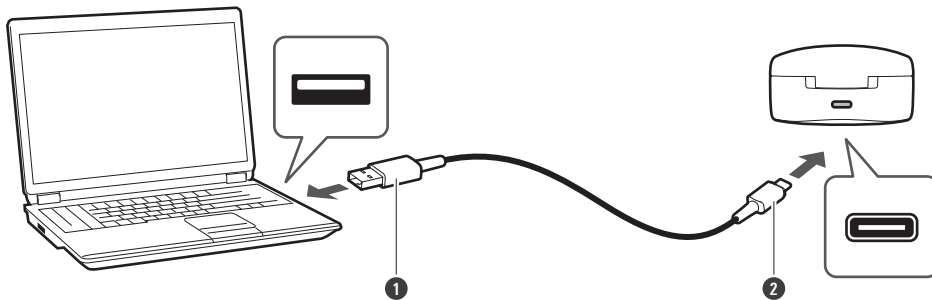

- ① USB Type-A
- ② USB Type-C

### 2 Place the headphones in the charging case.

- When charging the headphones, make sure the indicator lamps on the headphones light up. If they do not light up, remove the headphones and place them in the case again.

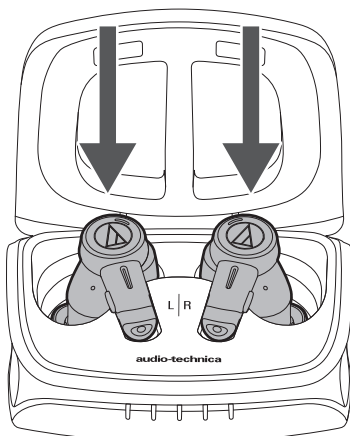



## Charging the battery

### 3 Connect the included USB charging cable (USB Type-A side) to the computer to start charging.

- While charging, the five charging indicator lamps light/flash as follows. (It may take several seconds for the charging indicator lamps to light.)

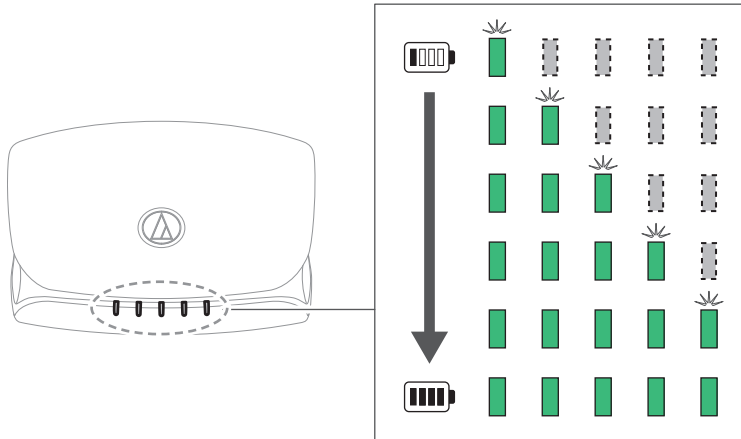

Indicator lamp	Status
Flashes/lights in green (the five charging indicator lamps light or flash according to the battery level).	Charging
Flashes/lights in purple (the five charging indicator lamps light or flash according to the battery level).	Charging (undergoing sanitization by the deep UV LED) <sup>[1]</sup>
Lights in green for 7 seconds, and then turns off.	Charging complete
All five indicator lamps flash in red quickly	Charging error <sup>[2]</sup>

[1] Once sanitization is complete, the indicator lamps light/flash in green again.

[2] The charging case or headphones may be hot. Allow the temperature of the product to cool sufficiently before charging in a well-ventilated place (10 to 35°C (50 to 95°F)) away from direct sunlight.

### 4 When charging is complete, disconnect the USB charging cable (USB Type-A side) from the computer.

### 5 Disconnect the USB charging cable (USB Type-C side) from the product's battery jack.



- When charging, make sure to use the included USB charging cable. The product may not charge with cables other than the included USB charging cable.
- Always make sure the headphones are not wet before charging. The headphones may not operate correctly or may not turn on if they are wet. Wipe the headphones with a dry cloth, shake them multiple times to remove any excess water, and allow the headphones to dry thoroughly before charging.

# Charging headphones without the USB charging cable

A rechargeable battery is built into the charging case. If you have charged the charging case, you can charge the headphones without using the USB charging cable.

### 1 Place the headphones in the charging case.

- While charging, the indicator lamp lights as follows. (It may take several seconds for the indicator lamp to light.)
- When charging the headphones, make sure the indicator lamps on the headphones light up. If they do not light up, remove the headphones and place them in the case again.

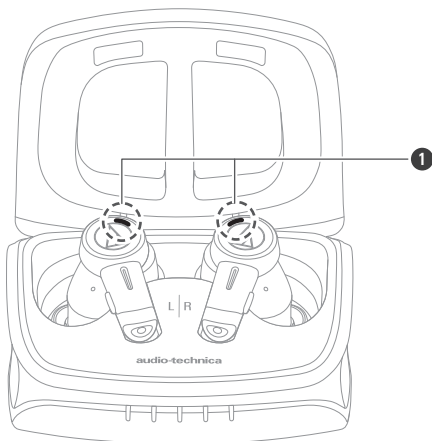

1 Indicator lamps

Indicator lamp	Status
Lights in white	Charging
Off	Charging complete / Charging case battery has no power

# Checking the battery level of the charging case and headphones

When opening/closing the cover of the charging case, the five charging indicator lamps light to indicate the battery level of the charging case and headphones.

### 1 Open the charging case cover.

- The indicator lamps light in blue to indicate the battery level of the headphones. The number of lit charging indicator lamps indicates the battery level.

## Charging the battery

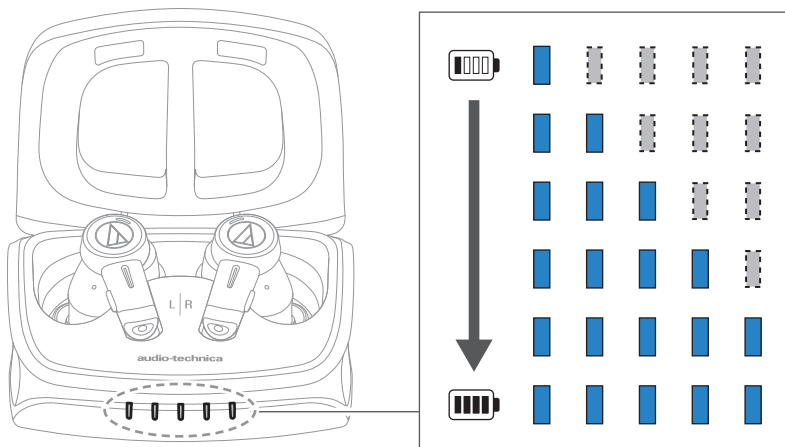

### 2 Close the charging case cover.

- The indicator lamps light in white to indicate the battery level of the charging case. The number of lit charging indicator lamps indicates the battery level.

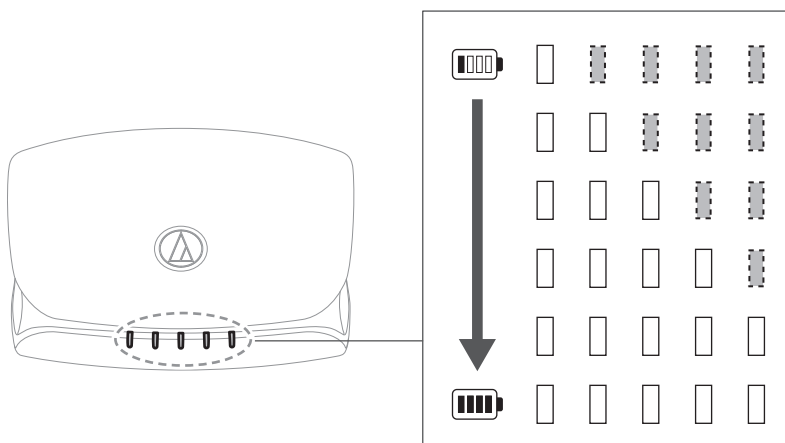

## Wireless charging

Wireless charging is possible using commercially available Qi wireless chargers.

- A wireless charger is not included. Please purchase one separately.
- Close the charging case cover and place the charging case on the wireless charger. The indicator lamps light and flash in green, after which charging begins. The charging indicator lamps light and flash in the same manner as when charging using a USB charging cable.
- When charging, refer to the user manual for the wireless charger to confirm the correct placement method.
- The maximum power that can be received by this product is 2.5 W.



- Charging simultaneously using a wireless charger and USB charging cable is not possible.

# Power supply ON/OFF

## Turning on the product

- 1 Remove the headphones from the charging case.

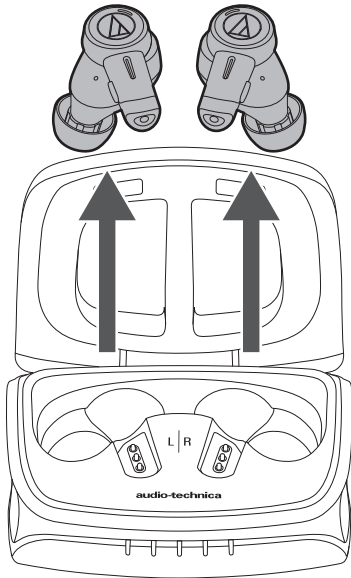

» The power will turn on automatically, and the indicator lamps will light in white and then flash.  
Voice guidance is played.



- Press and hold (for about 4 seconds) the multifunction buttons to turn the power on manually.
- It may take several seconds for the indicator lamps to light.
- See "Voice guidance" (p. 39) for more information on voice guidance.

## Turning off the product

- 1 Place the headphones in the charging case.

## Power supply ON/OFF

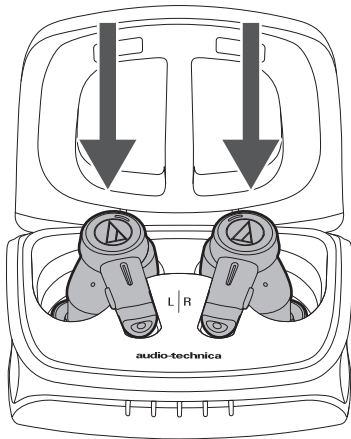

» The power will turn off automatically.



- Press and hold (for about 4 seconds) the multifunction buttons to turn off the power manually.

# Connecting via Bluetooth

To connect the product to a Bluetooth device, the product needs to pair (register) with the device.

## Pairing a Bluetooth device

- Read the user manual for the Bluetooth device.
- Place the Bluetooth device within 1 m (3.3') of the product to perform pairing correctly.
- Wear the product to hear voice guidance during pairing.

### 1 Remove the headphones (L (left) and R (right)) from the charging case.

- The indicator lamps will light in white, and then flash.

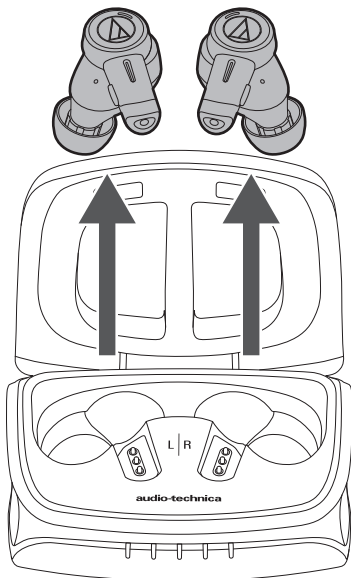

### 2 Use your Bluetooth device to begin the pairing process and search for the product. When your Bluetooth device finds the product, "ATH-TWX9" will be displayed on the device.

- For information about using your Bluetooth device, refer to the device's user manual.

### 3 Select "ATH-TWX9" to pair the product and your Bluetooth device.

- Some devices may ask for a passkey. In this case, enter "0000". The passkey may also be called a passcode, PIN code, PIN number, or password.

## Connecting via Bluetooth

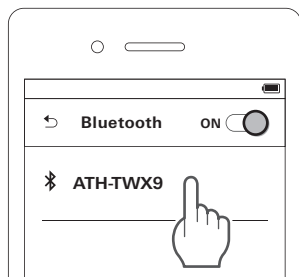

» The voice guidance will play the message “Bluetooth connected”, and the indicator lamp will flash slowly in white. This indicates pairing was successfully completed.

## Pairing with Fast Pair

In one touch, the product enables quick, effortless Bluetooth pairing with your Android devices. You can even check to see where you last placed it.



- 1** Turn on the Bluetooth function on an Android device configured with a Google account.
- 2** Remove the headphones (L (left) and R (right)) from the charging case and bring them close to the Android device.

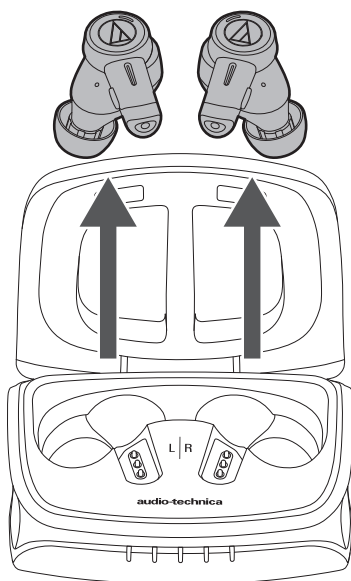

## Connecting via Bluetooth

**3 Touch the pairing notification that appears on your Android device.**

» **The voice guidance will play the message “Bluetooth connected”, and the indicator lamp will flash slowly in white. This indicates pairing was successfully completed.**

## About pairing

When connecting a new Bluetooth device, you need to pair it with the product. Once the Bluetooth device and the product are paired, you do not need to pair them again. The product supports multipairing, in which a connection history is saved. However, in the following cases you will need to pair again even if the Bluetooth device was paired once:

- If the product is deleted from the Bluetooth device’s connection history.
- If the product is sent out for repair.
- If the product is reset.

## Multipoint function

The product supports multipoint, which allows two Bluetooth devices to be connected at the same time. While you are listening to music with one device, you can answer a call that comes in from the other device. It is convenient if you have two smartphones, for example.

- Audio-Technica does not guarantee the operation of all combinations of Bluetooth devices.

### Connecting using multipoint

- 1 Pair with the first Bluetooth device.**
- 2 After pairing with the first device, turn off its Bluetooth feature.**
- 3 Pair with the second Bluetooth device.**
- 4 Turn on the Bluetooth feature of the first Bluetooth device.**



- If the product does not connect, restart its power.
- Up to two Bluetooth devices can be connected at the same time with multipoint. To connect a third Bluetooth device, disconnect one of the connected devices.
- Music cannot be played back on two devices at the same time. If music is playing on the first device, music will not play on the second device even if attempted. Stop playback on the first device before attempting to play music on the second device.



# Wearing the product

Insert the side of the product marked "L" (left) into the left ear and the side marked "R" (right) into the right ear.

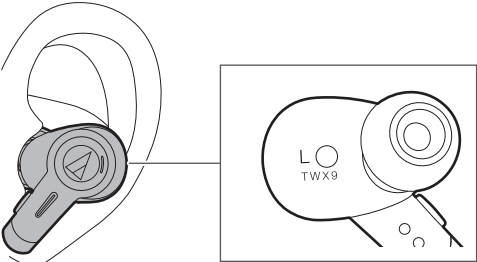

# Ear detection function

The product has a built-in ear detection sensor. The sensor detects when the product is removed from or inserted into the ear, and automatically performs operations during music playback.

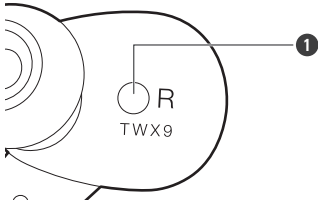

1 Ear detection sensor

## Unlocking

When removing the headphones from the charging case, the multifunction buttons and touch sensors are locked to prevent erroneous operations. The built-in ear detection sensors detect when the headphones are inserted into the ears to enable button and touch operations.

## Operations during music playback

When removing the headphones from your ears, music is paused automatically. Music playback will resume when the headphones are inserted into the ears again.

- Use the headphones or the Bluetooth device to first begin music playback.
- When both headphones are inserted into the ears, removing one or both headphones will pause the music. Music playback resumes when both headphones are inserted into the ears again.

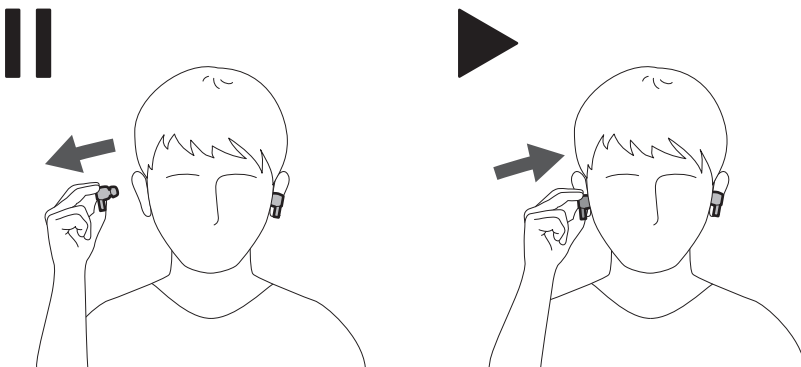

- When using the headphones, check that the indicator lamps are flashing (ready to use), and then insert the headphones properly into your ears.
- The ear detection function may not work if the headphones are not inserted properly.
- The ear detection function may not work if the headphone ear detection sensor is dirty. Use a dry cloth to clean the ear detection sensor if it is dirty.

## Ear detection function

### Turning ear detection function on/off

The ear detection function can be turned on or off using our "CONNECT" app. When the function is turned off, the multifunction buttons and touch sensors will remain unlocked, enabling button and touch operations without having to insert the headphones into your ears.

# Touch sensors

The product has touch sensors. When performing operations, touch the sensors using the pad of your finger, not the fingertip.

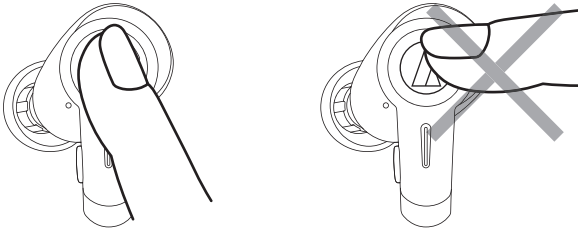

- Operate the touch sensor with one finger. Operating with a sharp-tipped object, such as a ballpoint pen or pencil, may result not only in incorrect operation, but also damage to the touch sensor.
- Do not touch the touch sensor with your fingertips. Doing so may cause your fingernail to break.
- If the product does not operate at all or as intended when touched, check to make sure that your other fingers, parts of your hand, or clothing items are not in contact when touching. Also, the product may not operate correctly if you are wearing gloves or if your fingertips are too dry.
- The product may not operate correctly if the touch sensor is dirty from sweat. Remove the dirt before operating the product.

# Using the product

The product can use Bluetooth wireless technology to connect to your device and play music, receive phone calls, etc. Use the product for whichever of these purposes suits your needs. Note that Audio-Technica cannot guarantee the operation of displays, such as the battery level display, or applications via Bluetooth devices.

## Listening to music

- To connect for the first time, pair the product and your device via Bluetooth wireless technology. If you have already paired the product and your Bluetooth device, turn on the Bluetooth device's Bluetooth connection before turning on the product.
- Use your Bluetooth device to start playback, referring to the device's user manual as necessary.

**1 Remove the headphones from the charging case and place them in your ears.**

**2 Start playback on your Bluetooth device.**

**3 Press the multifunction button on the L (left) side headphone once or twice in a row to adjust the volume (up or down).**

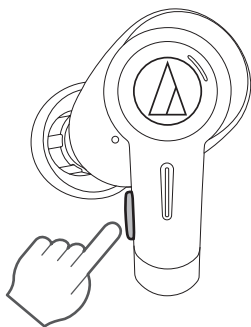

**4 To pause music, press the multifunction button on the R (right) side headphone.**

- Playback will be started or paused with every press.



- Listening to music is also possible with only one headphone by removing only one side from the charging case and putting it in your ear. When you use only one headphone, some functions are not available depending on which side is worn. Use the Bluetooth device for operation in such cases.

## Using the product

### R (right) side headphone multifunction-button operation

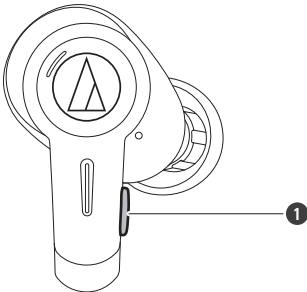

1 Multifunction button

Operation	Function
Press	Starts or pauses playback.
Press (twice)	Plays the next track.
Press (three times)	Plays the previous track / returns to the start of the track.

- The controls explained above may not be available on some smartphones.

### L (left) side headphone multifunction-button operation

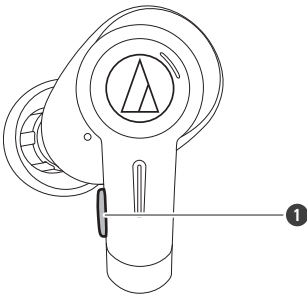

1 Multifunction button

Operation	Function
Press	Increases the volume by 1 level. <sup>[1][2]</sup>
Press (twice)	Decreases the volume by 1 level. <sup>[1][2]</sup>

[1] A beep is heard each time the volume is increased/decreased by 1 level.

[2] The volume control of some Bluetooth devices may not work well with the product.

- The controls explained above may not be available on some smartphones.

## Talking on the phone

If your Bluetooth device supports telephone features, you can use the product to talk on the phone.

## Using the product

- 1 Remove the headphones from the charging case and place them in your ears.**
- 2 Make/receive calls with your Bluetooth device.**
  - When your Bluetooth device receives a phone call, the product sounds a ringtone.
  - If a call is received while you are listening to music, music playback is paused.
- 3 To receive a call, press the multifunction button on the L (left) or R (right) side headphone.**
  - Calls can be answered from either the L (left) or R (right) side headphone.
- 4 Press the multifunction button on the L (left) side headphone once or twice in a row to adjust the volume (up or down).**

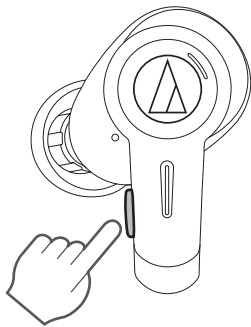

- 5 To end the call, press and hold (about 2 seconds) the multifunction button on the L (left) or R (right) side headphone.**
  - Calls can be ended from either the L (left) or R (right) side headphone.
  - If the call was received while listening to music, playback is resumed.
  - Music playback may not be resumed on some Bluetooth devices. In this case, music playback must be started manually.



- Making/receiving calls is also possible with only one headphone by removing only one side from the charging case and putting it in your ear. When you use only one headphone, some functions are not available depending on which side is worn. Use the Bluetooth device for operation in such cases.

### Notes for talking on the phone

When talking on the phone, make sure the tips of the headphones (microphones) are angled toward your mouth as shown in the figure. If the headphones are not oriented correctly, your voice may be too quiet for others to hear.

## Using the product

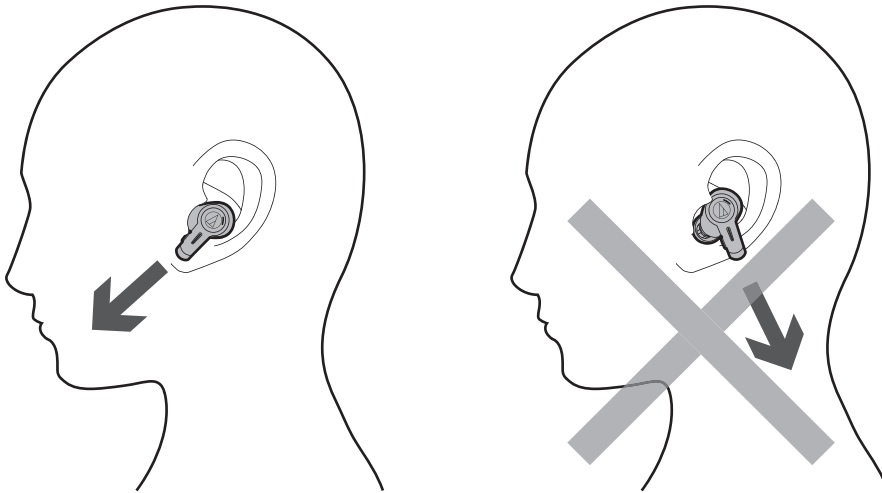

### R (right) side headphone multifunction-button operation

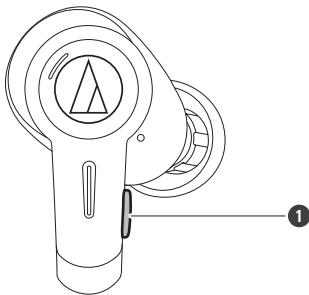

1 Multifunction button

Operation	Function
Press	Receiving a call: Answers the call.
Press (twice)	Mutes the microphone. <sup>[1]</sup>
Press and hold (about 2 seconds)	Receiving a call: Rejects the call. Making a call: Cancels the call. During a call: Ends the call.

[1] The mute operation using the multifunction button only mutes the headphones and does not activate the mute function on the Bluetooth device.

- The controls explained above may not be available on some smartphones.



### L (left) side headphone multifunction-button operation

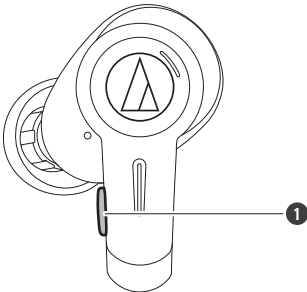

1 Multifunction button

Operation	Function
Press	Receiving a call: Answers the call. During a call: Increases the call volume by 1 level.
Press (twice)	During a call: Decreases the call volume by 1 level.
Press and hold (about 2 seconds)	Receiving a call: Rejects the call. Making a call: Cancels the call. During a call: Ends the call.

- The controls explained above may not be available on some smartphones.

## Quick hear-through function

This function enhances external sounds. The volume of music being played back decreases automatically. It is useful for when you want to listen to public transportation announcements or people's voices.

- 1 Press the multifunction button on the L (left) side headphone three times in a row.

### Turning off the quick hear-through function

The quick hear-through function turns off when the following operations and actions are performed.

- When the multifunction button on the L (left) or R (right) side headphone is pressed
- When the touch sensor on the L (left) or R (right) side headphone is touched
- When making/receiving calls
- When the headphones are removed from the ears (when the ear detection function is on)
- When music playback is stopped and then restarted
- When a connected Bluetooth device is operated



- The quick hear-through function cannot be used during a call.

## Using the product



- Depending on your surroundings, the ambient sounds may be difficult to hear even when using the quick hear-through function. Do not use the product in places that are dangerous if you cannot hear the surrounding sounds, such as places with heavy traffic.
- When the quick hear-through function is turned on, do not cover the microphone with your hand. If you do so, a loud sound (howling) will be emitted, and it may adversely affect your hearing ability.

## Ambience control

The product includes an ambience control function for switching between the noise-cancelling function and hear-through function. The functions can be switched from noise-cancelling (default), to off, or hear-through.

Function	Description
Noise-cancelling function	The microphone built into the product detects ambient noise and outputs a sound-cancelling signal to effectively reduce noise.
Hear-through function	This function allows you to hear surrounding sound via the built-in microphone while you listen to music.

### 1

**Press the touch sensor on the L (left) side headphone twice in a row.**

» **The functions can be switched from noise-cancelling (default), to off, or hear-through.**



- Occasionally it may be difficult to hear surrounding sound depending on the volume of the music, etc. that you are playing. In this case, turn down the volume of the music.
- Depending on your surroundings, the ambient sounds may be difficult to hear even when using the product's hear-through function. Do not use the product in places that are dangerous if you cannot hear the surrounding sounds, such as places with heavy traffic.
- When the hear-through function is turned ON, do not cover the microphone with your hand. If you do so, a loud sound (howling) will be emitted, and it may adversely affect your hearing ability.

## Noise-cancelling function

### Selecting noise-cancelling modes

Our "CONNECT" app features five preset modes. Users can select the appropriate mode for their situation, such as to match the ambient noise level or to concentrate at work.

- At the time of purchase, airplane mode is selected by default.

## Using the product

Function	Description
Home	This mode is recommended for when attempting to concentrate indoors, such as when at home.
Office/Study	This mode is recommended for when attempting to concentrate indoors, such as when at the office or when studying.
On The Go	This mode is recommended for reducing noises when in urban areas.
Train	This mode is recommended for reducing noises when using transportation, such as trains.
Airplane	This mode is recommended for reducing noises inside of airplanes.

### Two types of noise-cancelling systems

This product features two types of noise-cancelling systems. You can get the most from the noise-cancelling functions by using our "CONNECT" app.

Function	Description
Personalized noise-cancelling system	In this system, the manner in which the headphones are worn is detected in order to provide the same level of noise-cancelling performance regardless of ear type.
Optimized noise-cancelling system <sup>[1]</sup>	In this system, the headphones measure the noise level of the surrounding environment, based on which the system automatically sets the optimal level of noise cancelling.

[1] Setting can also be performed via the headphones.

### Optimizing the noise-cancelling function (optimized noise-cancelling system)

The headphones measure the surrounding noise level, based on which the optimal level of noise cancelling is automatically selected.

- Setting can also be performed using our "CONNECT" app.

#### **1 Touch and hold (about 3 seconds) the touch sensor on the L (left) side headphone.**

**» Measurement of the ambient noise level will then start, after which the optimal level of noise cancelling is automatically selected.**



- Optimization is not possible when the ambience control function is off or when hear-through is selected. Instead, operate with noise cancelling selected. For details on switching ambience control on and off, refer to "Ambience control" (p. 33).

### Speech recognition feature

Activation of the speech recognition feature (such as Siri) may be possible depending on your device.

**1 Touch and hold (about 2 seconds) the touch sensor on the R (right) side headphone.**

» **The speech recognition feature (such as Google Assistant or Siri) is activated.**

### Auto power off function

The headphones turn off automatically in the following situations.

- When the headphones are not inserted into the ears and are not connected to a Bluetooth device for 5 minutes
- When the headphones are not inserted into the ears after pairing is performed and music is paused for 30 minutes



- The auto power off function is turned off when the ear detection function is turned off.
- In some cases, such as when placing the headphones on the table a certain way, causing the ear detection function sensor to activate, the auto power off function may operate unexpectedly. Store the headphones in the charging case when not in use.

### App for smartphones

This product is compatible with our “CONNECT” app. The app gives you convenient access to various functions. It also allows you to update the product’s firmware.

<https://app.at-globalsupport.com>



**CONNECT App**  
iOS, Android

### What you can do with the app

The app allows you to use the following functions. For details, refer to the app screen.

## Using the product

Function	Description
Volume Adjustment Level	The number of volume adjustment steps can be changed.
Audio Codecs <sup>[1]</sup>	You can change the connection codec.
Ambience Control	You can switch between the noise-cancelling and hear-through functions. You can also select preset noise-cancelling modes and set the personalized noise-cancelling system or the optimized noise-cancelling system.
Quick Hear-Through	You can adjust quick hear-through types or the music playback volume during quick hear-through.
Equalizer	You can adjust the equalizer settings.
Low Latency Mode	Low latency mode reduces sound delay when playing games or watching videos.
L/R Balance Adjustment	You can adjust the left-right volume balance.
Side Tone	You can turn on or off the sidetone function that captures your own voice and ambient sounds through the microphone during a call (the function is on at the time of purchase).
Key Assign	You can set the function assigned to the multifunction button or touch sensor.
Touch Sensors	You can turn touch sensors on or off and set their sensitivity levels.
Voice Assistant	You can set what to activate via voice assistant operation.
Ear Detection	You can turn ear detection function on or off.
Guide Sounds	The product's voice guidance can be changed to a confirmation tone.
Connected Device Management	You can switch the connection by selecting the Bluetooth device you want to connect from the list of Bluetooth devices you have connected to so far.

[1] Changes can only be made on Android devices.

### 360 Reality Audio

360 Reality Audio is a new immersive music experience that uses Sony's object-based 360 Spatial Sound technology. Individual sounds such as vocals, chorus, piano, guitar, bass and even sounds of the live audience can be placed in a 360 spherical sound field, giving artists and creators a new way to express their creativity. Listeners can be immersed in a field of sound exactly as intended by artists and creators. Requires use of subscription to compatible online music service – subscription fees may apply. Please visit <https://www.sony.net/360RA> to check compatibility of the service.

# Snapdragon Sound™

This product is compatible with Qualcomm® Snapdragon Sound™.

Snapdragon Sound™ is a sound platform constructed using software featuring Qualcomm® audio technology. It enables users to enjoy a premium sound experience in all situations and from all sources including music, videos, games, and calls.

Connecting and using devices compatible with Snapdragon Sound™ enhances the performance of this product's specially designed high-resolution driver. It also enhances the entertainment experience of the user by enabling them to discover sounds they never knew existed, by providing a call quality that makes it feel as if the other person is right next to them, and by reducing sound delay when playing games or watching videos.

# Indicator lamp display

## Pairing

Status	Indicator lamp display pattern
Searching for devices	○ - ○ - ○ . . . Flashing white (gradually lighting up)

## Connecting

Status	Indicator lamp display pattern
Waiting to be connected	○○----○○----○○ . . . Flashing white (twice) in 4-second intervals
Connecting	○-----○-----○ . . . Flashing white in 5-second intervals
Music is playing	-- -- -- -- -- . . . Off

## Battery level

Status	Indicator lamp display pattern
Battery level is low	White in the pairing or connection status turns red.

# Voice guidance

The product plays English voice guidance in the following situations.

Situation	Voice guidance
Power is turned on	Voice guidance varies depending on the battery level. Battery level high Battery level medium Battery level low
Bluetooth is connected	Bluetooth connected
Bluetooth is disconnected	Bluetooth disconnected
Noise-cancelling function on (ambience control)	Noise-cancelling
Hear-through function on (ambience control)	Hear-through
Off (ambience control)	Off
Quick hear-through function off	Quick hear-through off
Noise-cancelling calibration starts	Calibration start
Noise-cancelling calibration is completed	Complete
Music is played	Play
Music is paused	Pause
Microphone mute off (during a call)	Mic on
Battery level is low	Low battery
No power due to dead battery	Please recharge



# Cleaning

Get into the habit of regularly cleaning the product to ensure that it will last for a long time. Do not use alcohol, paint thinners, or other solvents for cleaning purposes.

- Wipe any dirt off the headphones and charging case with a dry cloth. The headphones may not operate correctly or may not turn on if they are wet. Wipe the headphones with a dry cloth, shake them multiple times to remove any excess water, and allow the headphones to dry thoroughly before use.
- Immediately wipe off sweat or any other moisture from the charging case battery jack, the headphone charging terminals, etc. Failure to do so may result in a malfunction due to corrosion.
- Natural oils from the skin are particularly likely to build up on the eartip attachment parts (see figure). If these areas are not cleaned, the eartips can become detached. Clean them regularly. Do not touch the areas where sound is produced as they are delicate. Doing so may result in malfunction.
- If any moisture remains in the holes near the microphones (see figure), place the headphones on a dry cloth and shake several times to remove any moisture, and then allow the headphones to dry thoroughly before use.
- Wipe away any perspiration or dirt from the USB charging cable with a dry cloth immediately after use. Failure to clean the cable may cause it to deteriorate and harden over time, resulting in malfunction.
- If the USB terminal of the USB charging cable is dirty, wipe it off with a dry cloth.
- Clean the eartips by removing them from the headphones and manually cleaning them with a diluted mild detergent. After cleaning, dry before using again.

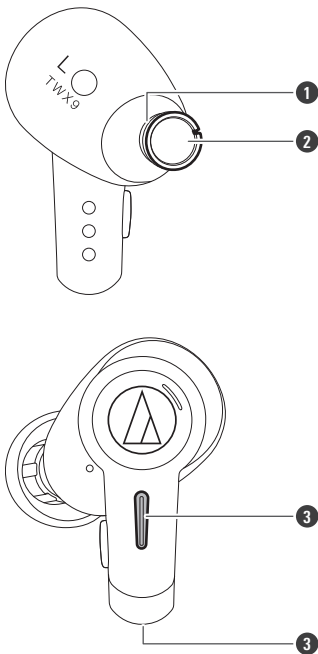

- ❶ Eartip attachment part
- ❷ Sound reproduction part
- ❸ Microphones



- If the product will not be used for an extended period of time, store it in a well-ventilated place free from high temperatures and humidity.

# Eartips

## Eartip size

The product includes silicone eartips in four sizes (XS, S, M, and L) and in three conduit lengths (short, standard, and long). At the time of purchase, the M-size (standard) silicone eartips are attached. To ensure the best sound quality, select the eartip size that is best suited for you, and adjust the eartips inside your ears for a snug fit. It may be difficult to hear bass sounds if the eartips do not fit snugly in your ears.

### Checking the conduit length

Confirm the length of the eartip conduit by checking its color.

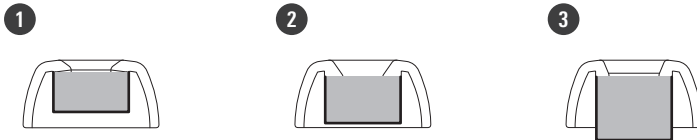

- 1 Short (white conduit)
- 2 Standard (gray conduit)
- 3 Long (black conduit)

### Checking the size

Confirm the size (XS, S, M, L) of the eartip by checking the number of holes on its back.

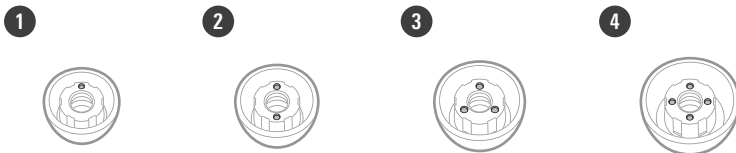

- 1 XS (one hole)
- 2 S (two holes)
- 3 M (three holes)
- 4 L (four holes)

## Replacing the eartips

Remove the old eartip and attach the new eartip by pushing it onto the headphone at an angle. Push firmly on the eartip so that the inside of the eartip expands, and push the eartip onto the post as far as it will go.

## Eartips

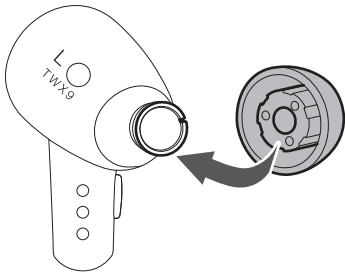

- Eartips are consumable parts that degrade through storage and use. If the eartips are loose and easily removed or if they appear to have degraded, purchase replacements.



- Periodically remove and clean the eartips as they become dirty easily. Using dirty eartips may cause the headphones themselves to become dirty, resulting in deteriorated sound quality.
- When reattaching eartips that were previously removed, be sure to check that they are securely attached. Injury or illness may occur if the eartips become detached and are left inside the ear.

# Forced pairing mode / reset

## If the product does not connect to a device (forced pairing mode)

If pairing cannot be cancelled or is not successful, you can use forced pairing mode to perform pairing again.

- 1** About 5 seconds after both headphones (L (left) and R (right) sides) are placed in the charging case (with battery remaining), touch and hold (about 4 seconds) the touch sensors of both headphones.
- 2** When the indicator lamps on both headphones light in red, release your fingers and remove the headphones from the charging case.  
  
» The product will switch to the "searching for devices" (pairing mode) state and you will be able to pair with your desired Bluetooth device.



- If the procedure cannot be completed as expected, remove the headphones from the charging case again and repeat the procedure from the beginning.

## If the product operates abnormally (reset)

Reset the product.

- 1** About 5 seconds after both headphones (L (left) and R (right) sides) are placed in the charging case (with battery remaining), touch and hold (about 10 seconds) the touch sensors of both headphones.
  - While touching and holding the touch sensors, the indicator lamps will light in red once after about 4 seconds, but keep touching and holding the touch sensors.
- 2** When the indicator lamps on both headphones start flashing in red, release your fingers and remove the headphones from the charging case.  
  
» Reset is complete.
- 3** Remove the product from the list of registered devices on your Bluetooth device.
- 4** Perform pairing again.



- If the procedure cannot be completed as expected, remove the headphones from the charging case again and repeat the procedure from the beginning.

# Troubleshooting

## ? Power is not supplied

- Charge the product.

## ? Unable to pair

- Confirm that the Bluetooth device communicates using Ver. 2.1+EDR or higher.
- Place the product and the Bluetooth device within 1 m (3.3') of each other.
- Set the profiles for the Bluetooth device. For procedures on how to set profiles, refer to the Bluetooth device's user manual.
- Remove the pairing information for the Bluetooth device then pair the product with this device again.
- Place the headphones in the charging case and close the cover, then remove the headphones and perform the operation again.
- Make sure you are not connected to any other previously connected Bluetooth device. If so, disconnect the product using the previously connected Bluetooth device, and then select the product on the Bluetooth device being connected to. Use forced pairing mode if you are unable to disconnect from a previously connected Bluetooth device. For details, refer to "If the product does not connect to a device (forced pairing mode)" (p. 43).
- Reset the product if it cannot be unpaired, connected, or does not operate as expected even after trying all other solutions. For details, refer to "If the product operates abnormally (reset)" (p. 43).

## ? No sound is heard / Sound is faint

- Turn on the power of the product and the Bluetooth device.
- Turn up the volume on the product and the Bluetooth device.
- Make sure that the product and Bluetooth device are connected by the A2DP (or audio connection).
- Disable pairing for the product and the Bluetooth device, then pair the product with this device again.
- Move away from obstacles between the product and the Bluetooth device, such as people, metal, or walls, and place the product and device closer together.
- Switch the sound output of the Bluetooth device to the product.
- Check whether the quick hear-through function is turned on/off. If the quick hear-through function is on, the volume of music being played back will decrease automatically. For details on operating the quick hear-through function, refer to "Quick hear-through function" (p. 32).

## ? Sound only comes out of one headphone

- Make sure there is battery level remaining.
- Place the headphones in the charging case and close the cover, then remove the headphones and perform the operation again.

### ? **Sound is distorted / Noise is heard / Sound cuts out**

- Turn down the volume on the product and the Bluetooth device.
- Keep the product away from devices that emit radio waves such as microwaves and wireless routers.
- Keep the product away from TVs, radios, and devices with built-in tuners. These devices can also be affected by the product.
- Turn off the equalizer settings of the Bluetooth device.
- Remove obstacles between the product and the Bluetooth device and place them closer together. For details, refer to "For a more comfortable Bluetooth communication experience" (p. 11).
- You may be able to improve the connection status by switching the connection codec to SBC. You can change it with our smartphone app. If you are using a connected device such as a smartphone or audio player that can change the connection codec, you may be able to set to SBC on that connected device. For details about the setting procedure, refer to the user manual of your connected device.
- The noise-cancelling effect may vary or a bleep (howling) may occur depending on how you wear the product. In these cases, take off the product and put the product in your ears again correctly.

### ? **Cannot hear the voice of the caller / Voice of the caller is too quiet**

- Turn on the power of the product and the Bluetooth device.
- Turn up the volume on the product and the Bluetooth device.
- Confirm that the product and Bluetooth device are connected via HFP (or phone connection).
- Disable pairing for the product and the Bluetooth device, then pair the product with this device again.
- Switch the sound output of the Bluetooth device to the product.

### ? **My voice is too quiet for others to hear**

- Make sure the product is oriented correctly with the tip (microphone) as close as possible to your mouth. For details, refer to "Notes for talking on the phone" (p. 30).

### ? **Charging case cannot be charged**

- Securely connect the included USB charging cable and charge the product.
- The charging case or headphones may be hot. Allow the temperature of the product to cool sufficiently before charging in a well-ventilated place (10 to 35°C (50 to 95°F)) away from direct sunlight.

### ? **Headphones cannot be charged**

- Make sure that the product is placed in the charging case correctly.

## Troubleshooting

- Make sure to close the charging case cover when charging.
- Charge the charging case.
- Wipe dirt off the charging terminal with a dry cloth.
- The charging case or headphones may be hot. Allow the temperature of the product to cool sufficiently before charging in a well-ventilated place (10 to 35°C (50 to 95°F)) away from direct sunlight.

### **Headphone indicator lamps flash in red quickly**

- After placing the headphone whose indicator lamp is flashing in red quickly in the charging case (with battery remaining), press and hold (about 2 seconds) the headphone multifunction button. The indicator lamp will then stop flashing.

### **Touch sensors operate abnormally**

- Has touch sensor sensitivity been changed using our “CONNECT” app? Touch sensor operation may vary depending on the unique finger characteristics and movements of the user. Changing touch sensor sensitivity may improve operability.



- For details about how to operate your Bluetooth device, refer to the device’s user manual.

# Specifications

## Headphones

<b>Type</b>	Dynamic
<b>Driver</b>	5.8 mm
<b>Sensitivity</b>	102 dB/mW
<b>Frequency response</b>	10 to 40,000 Hz
<b>Impedance</b>	16 ohms

## Microphone

<b>Type</b>	MEMS type
<b>Polar pattern</b>	Omnidirectional
<b>Sensitivity</b>	-38 dB (1 V/Pa, at 1 kHz)
<b>Frequency response</b>	100 to 16,000 Hz

## Communication specifications

<b>Communication system</b>	Bluetooth version 5.2
<b>Maximum RF output</b>	10 mW EIRP
<b>Maximum communication range</b>	Line of sight - approx. 10 m (33')
<b>Frequency band</b>	2.402 GHz to 2.480 GHz
<b>Modulation method</b>	GFSK, Pi/4DQPSK, 8DPSK
<b>Spread spectrum method</b>	FHSS
<b>Compatible Bluetooth profiles</b>	A2DP, AVRCP, HFP
<b>Supported codec</b>	Qualcomm® aptX™ Adaptive audio, Qualcomm® aptX™ audio, AAC, SBC
<b>Supported content protection method</b>	SCMS-T
<b>Supported sample rates</b>	44.1 kHz, 48 kHz, 96 kHz <sup>[1]</sup>
<b>Supported bit rates</b>	16 bit, 24 bit <sup>[2]</sup>
<b>Transmission band</b>	10 Hz to 47,000 Hz (when Qualcomm® Snapdragon Sound 96 kHz sampling) 20 Hz to 20,000 Hz



## Specifications

### Other

<b>Power supply</b>	Headphones: DC 3.85 V lithium ion battery Charging case: DC 3.85 V lithium polymer battery
<b>Charging time</b>	Headphones: Approx. 2.5 hours <sup>[3]</sup> Charging case: Approx. 3.5 hours (USB charging) <sup>[3]</sup> , Approx. 5.0 hours (wireless charging) <sup>[3]</sup>
<b>Operating time</b>	Continuous transmission time (music playback): Max. approx. 6.0 hours (headphones) <sup>[3]</sup> , Max. approx. 18.5 hours (if charging case is used in combination) <sup>[3]</sup>
<b>Weight</b>	Headphones: Approx. 5.4 g (0.19 oz) (L side), approx. 5.4 g (0.19 oz) (R side), Charging case: Approx. 55.9 g (2.0 oz)
<b>Water-resistant (drip-proof) performance</b>	IPX4 <sup>[4]</sup>
<b>Operating temperature</b>	5°C to 40°C (41°F to 104°F)
<b>Accessories</b>	USB charging cable (30 cm (12")), USB Type-A / USB Type-C), Eartips: Short (XS, S, M, L), Standard (XS, S, M, L), Long (XS, S, M, L)
<b>Sold separately</b>	Eartips: Short Eartips: Standard Eartips: Long

[1] When using Qualcomm<sup>®</sup> Snapdragon Sound.

[2] When using Qualcomm<sup>®</sup> Snapdragon Sound and Qualcomm<sup>®</sup> aptX<sup>™</sup> Adaptive audio.

[3] The figures above depend on operating conditions.

[4] Headphones only.

- For product improvement, the product is subject to modification without notice.

# Trademarks

- The **Bluetooth**<sup>®</sup> word mark and logos are registered trademarks owned by Bluetooth SIG, Inc., and any use of such marks by Audio-Technica Corporation is under license. Other trademarks and trade names are those of their respective owners.
- USB Type-C<sup>™</sup> is a trademark of USB Implementers Forum.
- Google Play is a trademark of Google LLC.
- "SONY" is a registered trademark of Sony Group Corporation.
- Snapdragon Sound, Qualcomm aptX, Qualcomm cVc and Qualcomm TrueWireless are products of Qualcomm Technologies, Inc. and/or its subsidiaries.
- Snapdragon and Snapdragon Sound are trademarks or registered trademarks of Qualcomm Incorporated.
- Qualcomm is a trademark of Qualcomm Incorporated, registered in the United States and other countries.
- Qualcomm TrueWireless is a trademark of Qualcomm Incorporated.
- aptX and cVc are trademarks of Qualcomm Technologies International, Ltd., registered in the United States and other countries.



**株式会社オーディオテクニカ**

〒194-8666 東京都町田市西成瀬2-46-1  
[www.audio-technica.co.jp](http://www.audio-technica.co.jp)

**Audio-Technica Corporation**

2-46-1 Nishi-naruse, Machida, Tokyo 194-8666, Japan  
[www.audio-technica.com](http://www.audio-technica.com)  
©2022 Audio-Technica Corporation  
Global Support Contact: [www.at-globalsupport.com](http://www.at-globalsupport.com)